



User Manual

DRS-100-3P

DIN Rail Energy Meter for Direct Connected Three Phase Electrical Systems up to 100 Amps

- Warnings**
- Caution: Risk of Electric Shock
- During normal operation, voltages hazardous to life may be present at some of the terminals of this unit.
 - At voltages below that specified in the Range of Use the meter may shut down. However, voltages hazardous to life may still be present at some of the terminals of this unit.
 - Installation and servicing should be performed only by qualified, properly trained personnel abiding by local regulations.
 - Ensure all supplies are de-energised before attempting connection or other procedures.
 - Terminals should not be user accessible after installation and external installation provisions must be sufficient to prevent hazards under fault conditions.
 - This unit is not intended to function as part of a system providing the sole means of fault protection - good engineering practice dictates that any critical function be protected by at least two independent and diverse means.
 - The unit does not have internal fuses therefore external fuses must be used for protection and safety under fault conditions.
 - Never open-circuit the secondary winding of an energized current transformer.
 - This product should only be operated with the CT secondary connections earthed.
 - If this equipment is used in a manner not specified by the manufacturer, protection provided by the equipment may be impaired.

Warnings

Important Safety Information is contained in the Maintenance section. Familiarize yourself with this information before attempting installation or other procedures. Symbols used in this document:

- Risk of Danger: These instructions contain important safety information. Read them before starting installation or servicing of the equipment.
- Caution: Risk of Electric Shock



1 Introduction

This document provides operating, maintenance and installation instructions. This unit measures and displays the characteristics of Single Phase Two Wire (1P2W), Three Phase Three Wire (3P3W) and Three Phase Four Wire (3P4W) networks. The measuring parameters include Voltage (V), Current (A), Frequency (Hz), Power (kW/KVA/KVAr), Power Factor (PF), Imported, Exported and Total Energy (kWh/kVArh). The unit also measures Maximum Demand Current and Power, this is measured over preset periods of up to 60 minutes.

It also comes with a complete comms capability with built in Pulse and RS485 Modbus RTU outputs, configuration is password protected.

This unit is 10(100)A direct connected. Configuration is password protected.

1.1 Unit Characteristics

The DRS-100-3P can measure and display:

- Phase to Neutral Voltage and THD% (Total Harmonic Distortion) of all Phases
- Line Frequency
- Current, Maximum Demand Current and Current THD% of all Phases
- Power, Maximum Power Demand and Power Factor
- Imported, Exported & Total Active Energy
- Imported, Exported & Total Reactive Energy

The unit has a Password-Protected set up menu for:

- Changing the Password
- System Configuration - 1P2W, 3P3W, 3P4W.
- Demand Interval Time
- Reset for Demand Measurements
- Pulsed Output Duration

1.2 RS485 Serial – Modbus RTU

RS485 serial port with Modbus RTU protocol to provide a means of remotely monitoring and controlling the Unit. Set-up screens are provided for setting up the RS485 port. Refers to section 4.8.

1.3 Pulse output

The meter provides two pulse outputs for active and reactive energy measurement. Both pulse outputs are passive type. The constant of pulse output 2 for active energy is 400impkWh, (unconfigurable), its width is fixed at 100ms.

The default constant of pulse output 1 is 400imp/kWh, default pulse width is 100ms. Both pulse constant and pulse width are configurable through the set-up menu of communication. Refers to section 4.3.

2 Start Up Screens

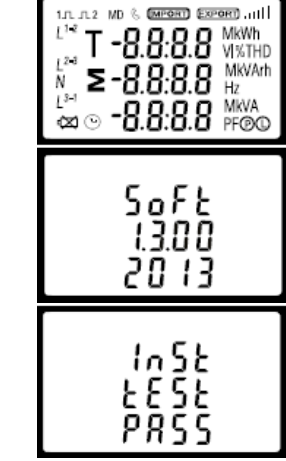

*After a short delay, the screen will display active energy measurements.

3 Measurements

The buttons operate as follows:

- Selects the Voltage and Current display screens. In Set-up Mode, this is the "Left" or "Back" button.
- Select the Frequency and Power factor display screens. In Set-up Mode, this is the "Up" button. Select the Power display screens.
- In Set-up Mode, this is the "Down" button.
- Select the Energy display screens. In Set-up mode, this is the "Enter" or "Right" button.

3.1 Voltage and Current

Each successive press of the button selects a new parameter:

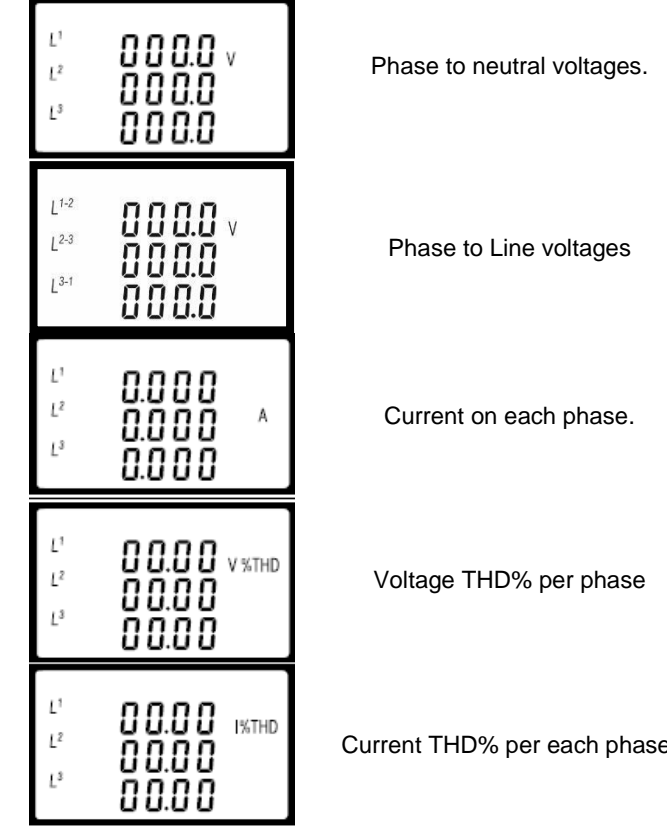

3.2 Frequency and Power Factor and Demand

Each successive press of the button selects a new range:

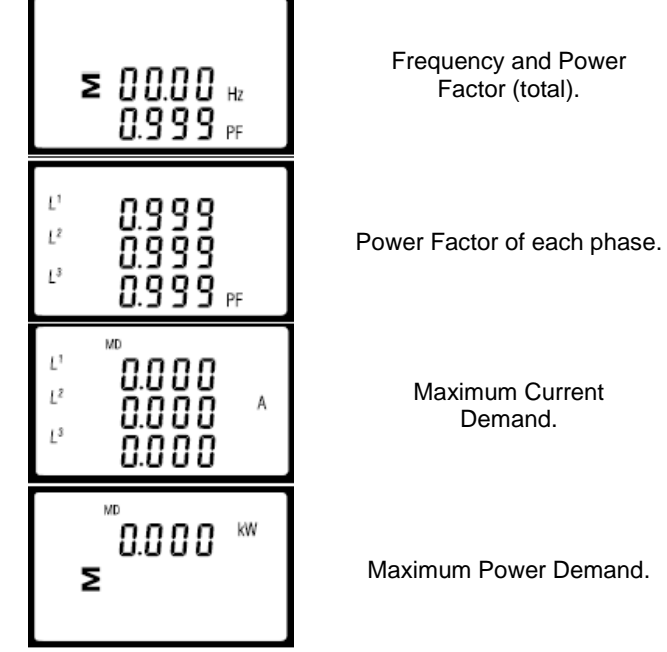

3.3 Power

Each successive press of the button select a new range:

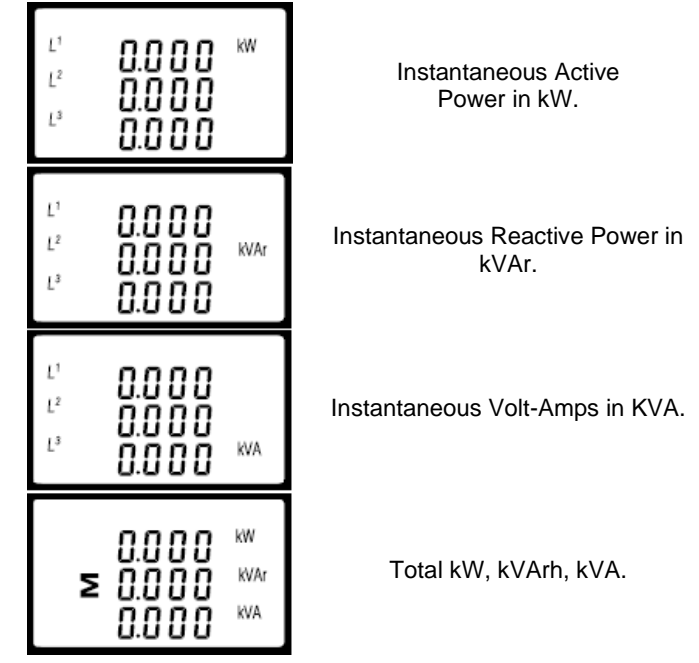

3.4 Energy Measurements

Each successive press of the button selects a new range:

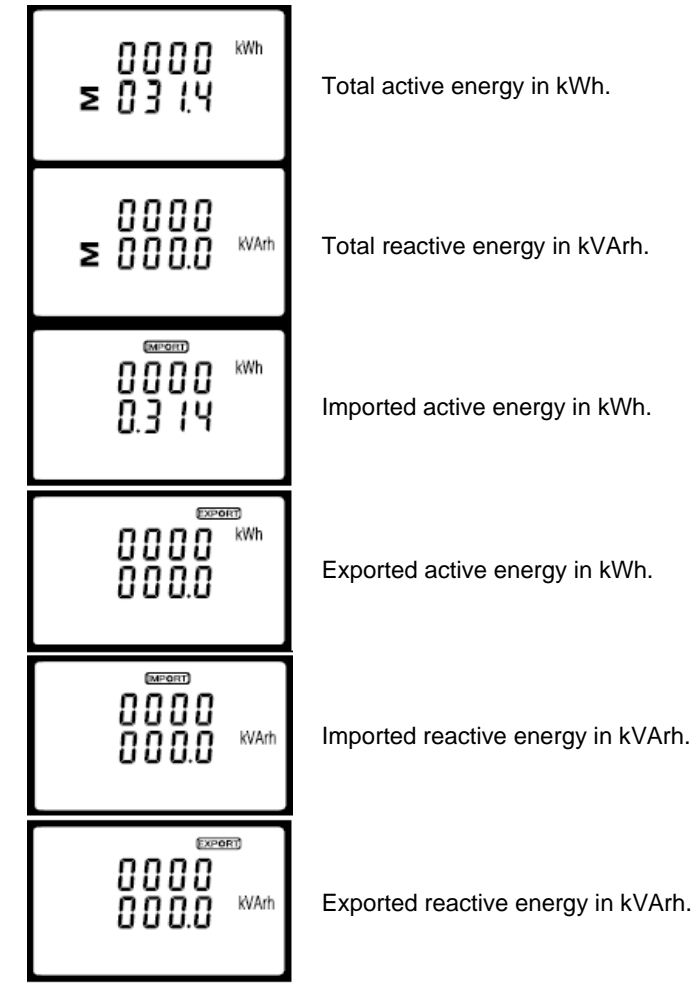

Please note the register is 9999999.9 display over two lines.

4 Set Up

To enter set-up mode, press the button for 3 seconds, until the password screen appears.

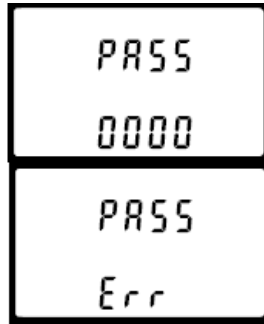

Setting up is password protected so you must enter the correct password (default '1000') before processing.

If an incorrect password is entered, the display will show: **PASS Err**

Once the correct password is entered, hold for 1 second to enter the setup menu.

To exit the setup menu, press repeatedly until the measurement screen is restored.

4.1 Set-up Entry Methods

Some menu items, such as password and Modbus address, require a four-digit number entry while others, such as supply system, require selection from a number of menu options.

CT ratio is not required. This product is directly connected.

4.1.1 Menu Option Selection

- Use the and buttons to scroll through the different options of the set up menu.
- Press to confirm your selection.
- If an item flashes, then it can be adjusted by the and buttons.
- Having selected an option from the current layer, press to confirm your selection. The SET indicator will appear.
- Having completed a parameter setting, press to return to a higher menu level. The SET indicator will be removed and you will be able to use the and buttons for further menu selection.
- On completion of all setting-up, press repeatedly until the measurement screen is restored.

4.1.2 Number Entry Procedure

When setting up the unit, some screens require the entering of a number. In particular, on entry to the setting up section, a password must be entered. Digits are set individually, from left to right. The procedure is as follows:

- The current digit to be set flashes and then can be adjusted using the and buttons.
- Press to confirm each digit setting. The SET indicator appears after the last digit has been set.
- After setting the last digit, press to exit the number setting routine. The SET indicator will be removed.

4.2 Communication

There is a RS485 port can be used for communication using Modbus RTU protocol. For Modbus RTU, parameters are selected from Front panel.

4.2.1 RS485 Address



From the set-up menu, use and buttons to select the address ID.

Press button to enter the selection routine. The current setting will be flashing.

Use and buttons to choose Modbus address (001 to 247).

On completion of the entry procedure, press button to confirm the setting and press button to return the main set-up menu.

4.2.2 Baud Rate



From the set-up menu, use and buttons to select the Baud Rate option.

Press to enter the selection routine. The current setting will flash.

Use and buttons to choose Baud rate 2.4k, 4.8k, 9.6k, 19.2k, 38.4k

On completion of the entry procedure, press to confirm the setting and press to return to the main set up menu.

4.2.3 Parity



From the set-up menu, use and buttons to select the parity option.

Press to enter the selection routine. The current setting will flash.



Use and buttons to choose parity (EVEN / ODD / NONE (default)).

On completion of the entry procedure, press to confirm the setting and press to return to the main set up menu.

4.2.4 Stop bits

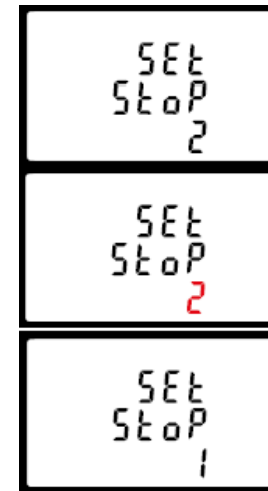

From the set-up menu, use and buttons to select the stop bit option.

Press to enter the selection routine. The current setting will flash.

Use and buttons to choose stop bit (2 or 1).

On completion of the entry procedure, press to confirm the setting and press to return to the main set up menu.

4.3 Pulse Output

This option allows you to configure the pulse output. The output can be set to provide a pulse for a defined amount of energy active or reactive. Use this section to set up the relay pulse output—Units: kWh, kVAh.

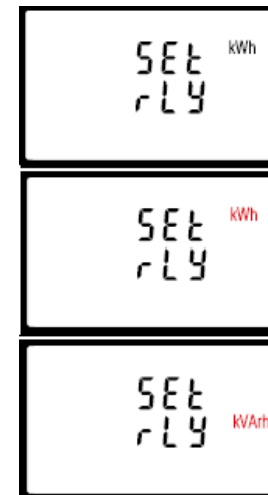

From the set-up menu, use and buttons to select the Pulse output option.

Press to enter the selection routine. The unit symbol will flash.

Use and buttons to choose kWh or kVAh.

On completion of the entry procedure, press to confirm the setting and press to return to the main set up menu.

4.3.1 Pulse rate

You can configure the pulse output to relate to a defined amount of imported or exported energy. This can also be set to use with active energy (kWh) or reactive energy (kVAh).

Please note there are limitations that need to be factored in when setting the pulsed output. This is based upon the relay output only being able to pulse 2 times in one second.

Pulse settings: 1 pulse per 0.01(10W) / 0.1(100W) / 1 (1kWh) /10(10kWh) / 100(100kWh) /1000 (1000kWh).

DFT= Default. Set as 1 (1kWh)

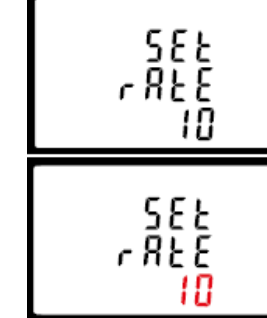

From the set-up menu, use and buttons to select the Pulse Rate option.

Press to enter the selection routine. The current setting will flash. 0.01/0.1/1/10/100kWh/ kVAh per pulse.

Use and buttons to choose pulse rate. On completion of the entry procedure, press to confirm the setting and press to return to the main set up menu.

4.3.2 Pulse Duration (DIT)

The energy monitored can be active or reactive and the pulse width can be selected as 200, 100 (default) or 60ms

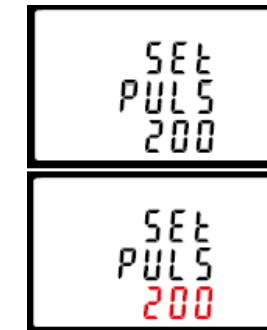

From the set-up menu, use and buttons to select the Pulse width option.

Press to enter the selection routine. The current setting will flash.

Use and buttons to choose pulse width. On completion of the entry procedure press to confirm the setting and press to return to the main set up menu.

4.4 Light Period (LP)

The light period is a programmable time (in minutes) that determines how long the display backlight remains on for before this goes into standby.

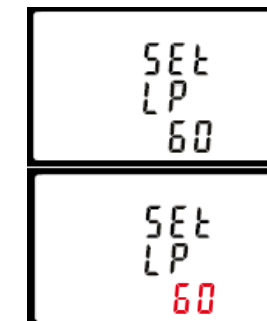

From the set-up menu, use the and buttons to select the reset option.

Press to enter the selection routine. The dlt will flash. The options are 0/10/30/60/120 minutes.

Press to confirm the setting and press to return to the main set up menu.

4.5 Supply System

The unit has a default setting of 3Phase 4wire (3P4). Use this section to set the type of electrical system.

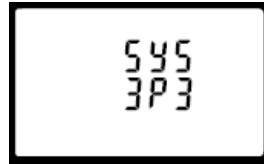

From the set-up menu, use and buttons to select the system option. The screen will show the currently selected power supply.



Press to enter the selection routine. The current selection will flash.

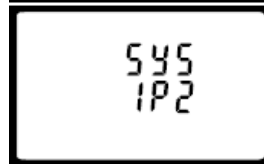

Use and buttons to select the required system option: 1P2(W), 3P3(W), 3P4(W).



Press to confirm the selection. SET indicator will appear.

Press to exit the system selection routine and return to the menu. SET will disappear and you will be returned to the main set-up Menu.

4.6 CLR

The meter provides a function to reset the maximum demand value of current and power.

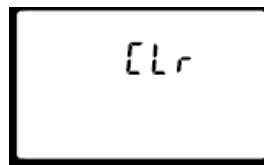

From the set-up menu, use and buttons to select the reset option.

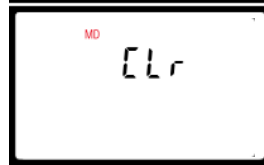

Press to enter the selection routine. The MD will flash.

Press to confirm the setting and press to return to the main set up menu.

4.7 Change Password



Use the and buttons to choose the change password option.



Press the to enter the change password routine. The new password screen will appear with the first digit flashing.



Use and to set the first digit and press to confirm your selection. The next digit will flash. Repeat the procedure for the remaining three digits.



After setting the last digit, SET will show.

Press to exit the number setting routine and return to the Set-up menu. SET will be removed.

4.8 DIT Demand Integration Time

This sets the period in minutes over which the current and power readings are integrated for maximum demand measurement. The options are: 0, 5, 8, 10, 15, 20 30, 60 minutes.



From the set-up menu, use and buttons to select the DIT option. The screen will show the currently selected integration time.



Press to enter the selection routine. The current time interval will flash.



Use and buttons to select the time required.



Press to confirm the selection. SET indicator will appear.

Press to exit the DIT selection routine and return to the menu.

5 Specifications

5.1 Measured Parameters

The unit can monitor and display the following parameters of a single phase two wire (1p2w), three phase three wire (3p3w) or three phase four wire (3p4w) system.

5.1.1 Voltage and Current

- Phase to neutral voltages 100 to 289V a.c. (not for 3p3w supplies).
- Voltages between phases 173 to 500V a.c. (3p supplies only).
- Continuous Overload voltage 120%
- Percentage total voltage harmonic distortion (THD%) for each phase to N (not for 3p3w supplies).

- Percentage voltage THD% between phases (three phase supplies only).
- Current 100A (Direct connected)
- Continuous Overload current 120%
- Current THD% for each phase.
- Burden <10VA (nom 2VA)
- Self powered from any phase

5.1.2 Power factor and Frequency and Max. Demand

- Frequency in Hz
- Instantaneous power: Power 0 to 99999 W
- Reactive power 0 to 99999 VAR
- Volt-amps 0 to 99999 VA
- Maximum demanded power since last Demand reset
- Maximum neutral demand current, since the last Demand reset (for three phase supplies only)

5.1.3 Energy Measurements

- Imported/Exported active energy 0 to 9999999.9 kWh
- Imported/Exported reactive energy 0 to 9999999.9 kVArh
- Total active energy 0 to 9999999.9 kWh
- Total reactive energy 0 to 9999999.9 kVArh

5.2 Measured Inputs

Voltage inputs through 4-way fixed connector with 25mm² stranded wire capacity. Single phase two wire(1p2w), three phase three wire(3p3w) or three phase four wire(3p4w) unbalanced. Line frequency measured from L1 voltage or L3 voltage.

Voltage AC (Un)	3x230(400)V
Voltage Range	80~120% Un 10A AC
Base Current (Ib)	100A AC
Max. Current (Imax)	0.5A
Min. Current (Imin)	0.4% of Ib
Starting current Power consumption	≤ 2W/10VA for the voltage measuring circuit ≤ 4VA for the current measuring circuit

5.3 Accuracy

- Voltage 0-5% of range maximum
- Current 0-5% of nominal
- Frequency 0-2% of mid-frequency
- Power factor 1% of unity (0.01)
- Active power (W) ±1% of range maximum
- Reactive power (VAR) ±1% of range maximum
- Apparent power (VA) ±1% of range maximum
- Active energy (Wh) Class 1 IEC 62053-21
- Reactive energy (VARh) ±1% of range maximum
- Total harmonic distortion 1% up to 31st harmonic
- Response time to step input 1s, typical, to >99% of final reading, at 50 Hz.

5.4 Interfaces for External Monitoring

Three interfaces are provided:

- RS485 communication channel that can be programmed for Modbus RTU protocol
- Relay output indicating real-time measured energy. (configurable)
- Pulse output 400imp/kWh (not configurable)

The Modbus configuration (baud rate etc.) and the pulse relay output assignments (kW/kVArh import/export etc.) are configured through the set-up screens.

5.4.1 Pulse Output

Opto-coupler with potential free SPST-NO Contact (Contact range 5-27VDC / Max current input: Imin 2mA and Imax 27mA DC). The pulse output can be set to generate pulses to represent kWh or kVArh.

Rate can be set to generate 1 pulse per:
0.01 = 10 Wh/VArh
0.1 = 100 Wh/VArh
1 = 1 kWh/kVArh
10 = 10 kWh/kVArh
100 = 100 kWh/kVArh

Pulse width 200/100/60 ms.

5.4.2 RS485 Output for Modbus RTU

For Modbus RTU, the following RS485 communication parameters can be configured from the set-up menu:

Baud rate 2400, 4800, 9600, 19200, 38400
Parity none (default) / odd / even
Stop bits 1 or 2
RS485 network address nnn – 3-digit number, 1 to 247

Modbus™ Word order Hi/Lo byte order is set automatically to normal as defined by IEEE 754. It cannot be configured from the set-up menu.

5.5 Reference Conditions of Influence Quantities

Influence Quantities are variables that affect measurement errors to a minor degree. Accuracy is verified under nominal value (within the specified tolerance) of these conditions.

- Ambient temperature 23°C ±2°C
- Input frequency 50 or 60Hz ±2%
- Input waveform Sinusoidal (distortion factor < 0.005)
- (if AC) factor < 0.05
- Magnetic field of external origin Terrestrial flux

5.6 Environment

- Operating temperature -25°C to +55°C*
- Storage temperature -40°C to +70°C*
- Relative humidity 0 to 95%, non-condensing
- Altitude Up to 2000m
- Warm up time 5s
- Vibration 10Hz to 50Hz, IEC 60068-2-6, 2g
- Shock 30g in 3 planes

*Maximum operating and storage temperatures are in the context of typical daily and seasonal variation.

5.7 Mechanics

- DIN rail dimensions 76 x 100 mm (WxH) per DIN 43880
- Mounting DIN rail (DIN 43880)
- Sealing IP51 indoor
- Material UL 94 V-0 Self-extinguishing

6 Installation and Maintenance

6.1 Installation notes

Units should be installed in a dry position, where the ambient temperature is reasonably stable and will not be outside the range -25 to +55°C. Vibration should be kept to a minimum. Preferably, mount the Integra so that the display contrast is not reduced by direct sunlight or other high intensity lighting.

6.2 Input Wiring and Fusing

Choose fuses of a type and with a breaking capacity appropriate to the supply and in accordance with local regulations.

A switch or circuit breaker allowing isolation of supplies to the unit must be provided where practical. In primary metering applications, ensure the supply is isolated before any maintenance on the product. Tampering with the product seals may contravene local laws.

6.3 Wire Size

Voltage and current terminal blocks will accept 2.5mm² to 25mm² stranded cable. Torque settings: Input terminals: 2.5Nm, modbus, pulse outputs terminals: 0.2Nm

6.4 Maintenance

The front of the case should be wiped with a dry cloth only, using minimal pressure. If necessary wipe the rear case with a dry cloth.

No user serviceable parts.

7 Declaration of Conformity

We, Tyco Electronics UK Ltd, declare under our sole responsibility as the manufacturer that the poly phase multifunction electrical energy meter "DRS-100-3P" correspond to the production model described in the EC-type examination certificate and to the requirements of the Directive 2004/22/EC EC type examination certificate number 0120/SGS0250. Identification number of the NB 0120.

8 Meter

8.1 Dimensions

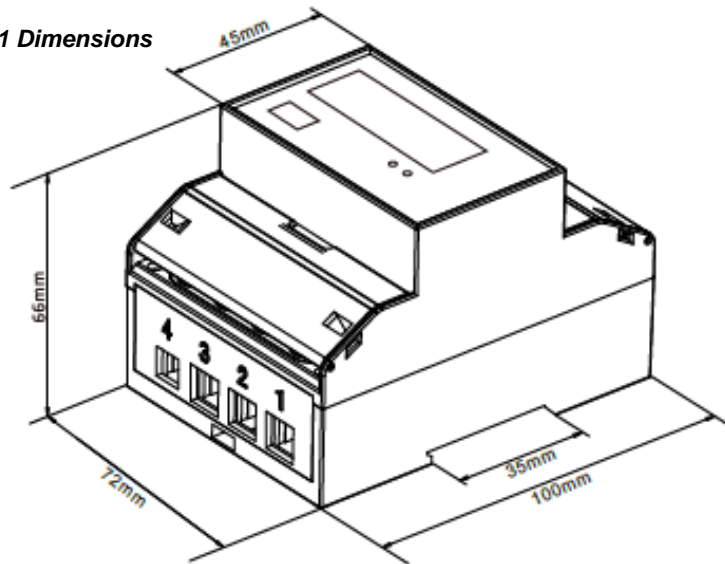

8.2 Appearance



9.3 Three phase four wires

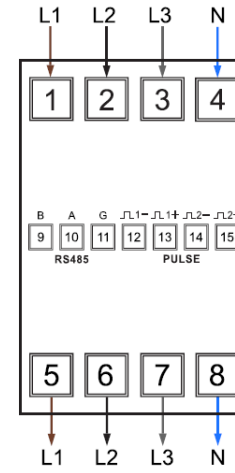

9 Wiring Diagram

9.1 Single phase two wires

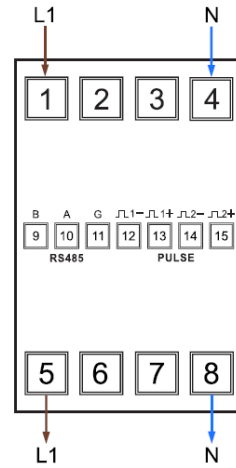

9.2 Three phase three wires

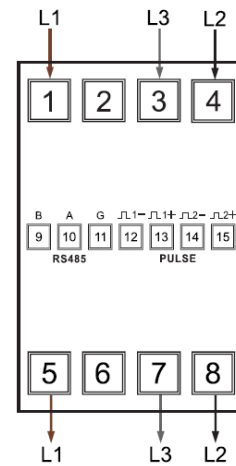

Explanation of Symbols

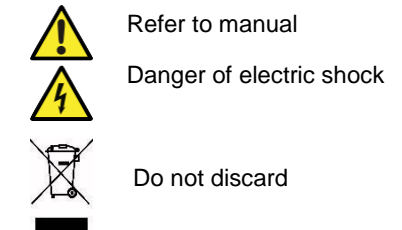

While TE has made every reasonable effort to ensure the accuracy of the information in this catalogue, TE does not guarantee that it is error-free, nor does TE make any other representation, warranty or guarantee that the information is accurate, correct, reliable or current. TE reserves the right to make any adjustments to the information contained herein at any time without notice. TE expressly disclaims all implied warranties regarding the information contained herein, including, but not limited to, any implied warranties of merchantability or fitness for a particular purpose. The dimensions in this catalogue are for reference purposes only and are subject to change without notice. Specifications are subject to change without notice. Consult TE for the latest dimensions and design specifications. TE connectivity (logo), TE (logo) and TE Connectivity are trademarks of the TE Connectivity Ltd. family of companies. Crompton is a trademark of Crompton Parkinson and is used by TE Connectivity under a licence. Other logos, product and company names mentioned herein may be trademarks of their respective owners

TE Energy – innovative and economical solutions for the electrical power industry: cable accessories, connectors & fittings, insulators & insulation, surge arresters, switching equipment, street lighting, power measurement and control.

Tyco Electronics UK Ltd

TE Energy
Freebournes Road
Witham, Essex CM8 3AH
Phone: +44 (0)870 870 7500
Fax: +44 (0)870 240 5289
Email: Crompton.info@te.com
www.crompton-instruments.com

