



Crompton Instruments DIN, Fiesta, Challenger and Sealed Analogue Meters

Analogue Instruments

High quality analogue instruments designed to measure an extensive range of electrical and electronic parameters. This comprehensive range offers DIN instruments, ANSI switchboard meters, panel indicators, sealed and ruggedised instruments, and complementary selector switches for line-to-line and line-to-neutral readings. Instruments are precision engineered and robust in design, ensuring accurate measurement and display in the most demanding of environments. All instruments are available in a range of styles, sizes and specifications to meet the exacting needs of your industry.



Contents

DIN Panel Meters

An extensive range of 48, 72, 96 and 144mm DIN style panel meters. Short-scale ammeters, voltmeters and frequency meters incorporate slide-in dials and terminal covers. Long-scale meters are also available. Meters for power or energy contain in-built transducers and can be customised to suit many different system configurations and ranges.

Instrument Selector Switches

Panel mounted selector switches offering a 7-position voltmeter switch and a 4-position ammeter switch for reading line-to-line or line-to-neutral voltage and phase current.

Saxon Series Panel Indicators

A range of 2½", 3½" and 4½" surface mount panel meters utilising pivot and jewel mechanisms and offering IP54 protection. The range offers iron vane and moving coil AC and DC ammeters and voltmeters, elapsed time and frequency meters. UL approvals.

016 Series Fiesta Panel Indicators

A robust range of short-scale 3½" surface mount panel meters offering IP55 protection and featuring wide-view contoured windows. The range offers iron vane and moving coil AC and DC ammeters and voltmeters, elapsed time and frequency meters. UL approvals.

Challenger Analogue Panel Meters

Challenger analogue panel meters feature a detachable lower fascia plate, which allows either surface or window mounting. Meters use a high torque pivot and jewel movement.

078/080/087 Series Sealed and Ruggedised Indicators

Designed to comply with industrial, marine and military specifications, these 240° and 90° scale meters are resistant to extreme shock, vibration, temperature, dirt and humidity. The range offers a wide range of bezel sizes fitted with toughened glass.

Page

2 - 21

22

23 - 24

25 - 27

28 - 32

33 - 37

Features

- Extensive range
- Accurate measurement and display of electrical and electronic parameters
- Wide range of case styles and specifications
- Maximum reliability in harsh environments

Benefits

- Low cost
- Local indication
- Ease of installation
- Minimal training
- Low maintenance
- Reasonable accuracy

Applications

- Switchgear
- Distribution systems
- Generator sets
- Control panels
- Energy management
- Building management
- Utility power monitoring
- Process control
- Motor control

Approvals

- UL, CSA, ABS, LRS, BV

Features

- A range of the most popular short-scale measuring instruments in 4 case sizes
- Shock resistant sprung pivot and jewel movement
- Terminal covers supplied as standard
- EMC hard frequency meters are fully EMC and LVD compliant
- 1/4" 'fast on' terminals available

Benefits

- Low cost
- Local indication
- Ease of installation
- Minimal training
- Low maintenance
- Customised options and features

Applications

- Switchgear
- Distribution systems
- Generator sets
- Control panels
- Energy management
- Building management
- Utility power monitoring
- Process control
- Motor control

Approvals

- Lloyds:
- 03/00055 - Moving coil meters
- 03/00056 - Moving iron meters
- 03/00057 - Frequency meters

DIN Panel Meters – Short scale

A range of 48, 72, 96 and 144mm DIN style panel meters measuring all electrical parameters and featuring moving coil or moving iron movements. All meters incorporate slide-in dials and terminal covers as standard. A range of customised options is available.

Movements

Moving Coil Meter

Centre cored, self shielding moving coil movement, using pivots, hairsprings and sprung jewels. Seven variations have been designed in movement ranges: all intermediate ranges are achieved by shunting the next lowest range. All DC voltmeters are 1000 ohms per volt, rectified product run at 900 ohms per volt, millivolt meters use the 5 milliamp movement.

Moving Iron Meter

Clapper type repulsion design using pivots, hairsprings and jewel movements. The bottom jewel is oil filled to provide damping while the top is sprung for resilience. All voltmeters are manufactured with external voltage dropper resistors to substantially reduce the self heating effects.

Frequency Meter

Meter uses a 100 microamp 4000 ohm movement driven by an EMC hard frequency conversion circuit.

Dials, Scales and Pointers

Standard dials are white matt with black printed scales and bar knife-edge pointers. Black dials with white or yellow scales and pointers are also available. Interchangeable slide-in dials are used on the E242, E243, E244 and E246 90° moving iron, moving coil and frequency meter models.

General options include red supplementary pointers, red indexes (quadrant scales), red, green or blue lines, bands or segments, finely spaced divisions, multi-scales, special scales and captions to customer's requirements.

Specifications

Type of instrument	Moving iron for current and voltage	Moving coil for current and voltage	Moving coil with rectifiers for current and voltage	Moving coil with built-in transducer for frequency measurement	Maximum demand indicators	Combined MDI with moving iron movement
Format	48 x 48mm 72 x 72mm 96 x 96mm 144 x 144mm	48 x 48mm 72 x 72mm 96 x 96mm 144 x 144mm	48 x 48mm 72 x 72mm 96 x 96mm 144 x 144mm	72 x 72mm 96 x 96mm 144 x 144mm	72 x 72mm 96 x 96mm	96 x 96mm
Movement type	Sprung pivot jewel with silicon oil damping	Sprung pivot jewel with eddy current damping	Sprung pivot jewel with eddy current damping	Sprung pivot jewel with eddy current damping	Sprung pivot jewel with silicon oil damping	Sprung pivot jewel with silicon oil damping
Burden	0.5VA-15A then 0.8VA voltmeters 4.5VA	See detailed specifications	See detailed specifications	See detailed specifications	2.5VA	3VA
Accuracy	1.5% to DIN43780	1.5% to DIN43780	2.5% to DIN43780	0.5% to DIN43780	3%	3% on MDI 1.5% ammeter
Input type	AC current or voltage	DC current or voltage	AC current or voltage	AC voltage	AC current	AC current
Measuring range	6-600V 100mA-100A 48mm only up to 40A	50mV-600V 100µA-40A, 44mm only 25A	15-600V 1mA-100mA and 1A & 5A	57.7V @ 45Hz 500V @ 44Hz	0-1/1.2A or 0-5/6A 8, 15 or 20 minute delays	1-6A 8, 15 or 20 minute delays 0-5A/6A instantaneous
Dielectric voltage withstand test	3kV AC	3kV AC	3kV AC	3kV AC	3kV AC	3kV AC

General Specifications

Performance:	BSEN60051
Measuring ranges:	DIN43701
Accuracy overload:	BSEN60051
Dimensions:	DIN43700
Scale marking generally to:	DIN43802
Magnetic influence:	BSEN60051
Safety:	BSEN61010-1
Terminals:	Clamp strap M4 for up to 25A. Clamp strap M8 for over 25A 1/4" spade terminals available for models E243 and E244
Humidity range:	Up to 95% RH (non condensing)
Test voltage @50Hz:	3kV RMS for 1 minute
Ammeter ranges:	1.0/1.2/1.5/2.5/5/6 and decade multiples thereof
Overload AC current:	x 1.2 continuous x 10 for 5 seconds
AC voltage and frequency:	x 1.2 continuous x 2 for 5 seconds
Standard calibration:	23°C. Calibration at other temperatures available on request
Operating temperature:	-20°C to +60°C
Damping time:	Less than 3 seconds
Enclosure code:	IP52 as standard IP54 on request
Case and base:	Grade UL94V0
Case:	Dimensions and panel cut out conform to IEC473, DIN43700. Case made from glass filled polycarbonate self-extinguishing and non drip in accordance with UL94V-O
Bezel:	Slim-line DIN43802, black as standard
Bezel window:	Standard sheet glass, with zero adjusters where appropriate. Non reflecting glass or polycarbonate shatterproof windows are available
Installation:	Installations in switchboard panel or mosaic arrangement on equipment or machine with a panel thickness of up to 40mm in a horizontal or vertical plane
Fixing on panel:	Swivel captive fasteners, which can be fixed at either corner
Mounting position:	Normal vertical mounting or as indicated on the scale in accordance with DIN16257. A deviation of $\pm 15^\circ$ is permissible
Insulation group:	Insulation resistance more than $5M\Omega @ 500V$
Environmental:	Measurement category III IEC 1010-1 Pollution degree 2 IEC 1010-1 Electrical rating 600V RMS (920V peak)
Approvals:	EMC, LVD and Lloyds



DIN16257 symbol meaning for calibration position



Inclination of dial surface.

Required orientation must always be stated when ordering if other than vertical mounting is required.

Dimensions

Moving coil measuring range		Moving iron measuring range	
6-60A	C=67mm	0-30A	C=64mm
>60A	C=78mm	>30A	C=67mm

Max. panel thickness = 40mm

D	A	B
48 x 48	45 x 45	4
72 x 72	68 x 68	4
96 x 96	92 x 92	4
144 x 144	138 x 138	4

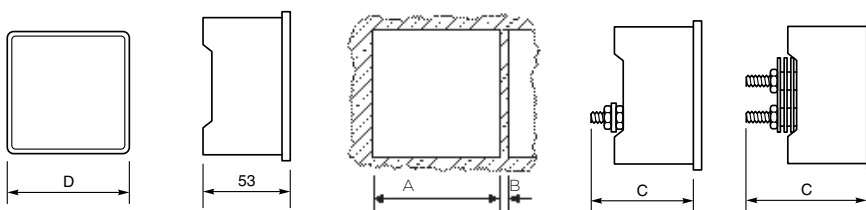

Moving Iron AC Ammeters and Voltmeters

Designed to measure AC current or voltage, these meters indicate true RMS values and are substantially independent of system waveform. Scales are calibrated down to 20%, and ammeters can have overload scales of x2, x3, x5 or x6 for motor start duty. Ammeters can be supplied for use with -/1A or -/5A current transformers, whilst voltmeters can be scaled for use with voltage transformers. Meters can be used to measure DC at reduced accuracy.



Connections

AC Ammeter

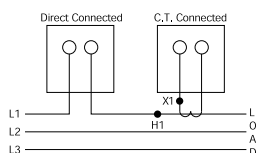
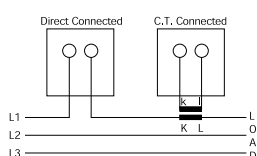

AC Voltmeter

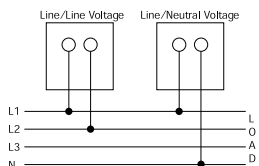

Specifications

Accuracy:	Class 1.5
Frequency:	50 or 60Hz, (400Hz on request)
Burden at 50Hz:	Ammeters: 0.5VA voltmeters: Up to 4.5VA maximum
Ratings:	Ammeters: 0.5-100A AC direct connected (40A for E242-75A and E246-02A) Maximum system voltage 600V AC Low load/high middle, maximum 10A
Voltmeters:	6-600V

Product Codes

Bezel size mm	48	72	96	144
Scale length mm	42	65	94	145
AC ammeter	E242-75A	E243-02A	E244-02A	E246-02A
x2 overload ammeter	E242-752A	E243-022A	E244-022A	-
x3 overload ammeter	E242-753A	E243-023A	E244-023A	-
x5 overload ammeter	E242-755A	E243-025A	E244-025A	-
x6 overload ammeter	E242-756A	E243-026A	E244-026A	-
AC voltmeter	E242-75V	E243-02V	E244-02V	E246-02V

Frequency Meters

Frequency meters use an integral electronic converter and a moving coil indicator. These easy to read meters have accuracy Class 0.5.



Connections

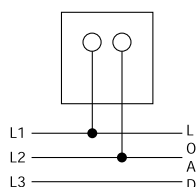

Specifications

Ratings:	100-125V AC 200-250V AC 380-440V AC* 500V AC* *Use E242-89A and 253-THZ in place of E242-41S for voltages over 380V Models available for use with VTs
Frequency:	0.5%: 45/55Hz, 55/65Hz, 45/65Hz, 360/440Hz
Burden:	4VA maximum

Product Codes

Bezel size mm	48	72	96
Scale length mm	42	65	94
Product codes	E242-41S	E243-41S	E244-41S

Maximum Demand Indicators

The thermal/time characteristics of MDI meters monitor the most economic use of cable, fusegear and transformers. The directly heated bimetal element indicates mean RMS current over 8, 15, or 20 minutes, and a red slave pointer shows the highest value reached. The reset knob is wire sealable. Scales are calibrated to match the CT primary plus 20% overload. End values are selected from: 1.2, 1.8, 2.4, 3, 3.6, 4.8, 6, 7.2, 9 amps and their multiples of 10 and 100.

Specifications

Accuracy:	Class 3
Options:	5A for use with separate CT 5/5A saturating CT 1/5A saturating CT
Burden at 50 Hz:	MDI - 2.5VA, CT - 2VA
Overload withstand:	Standard: 5 x FL for 5 seconds, 10 x FL for 1 second. With saturating CT: 10 x FL for 3 seconds, 20 x FL for 1 second
Frequency:	50/60Hz

Product Codes

Bezel size mm	72	96
Scale length mm*	65	94

Product codes

8 minute time lag

without limiting CT for use with 5A CT	E243-16B	E244-16B
--	----------	----------

15 minute time lag

without limiting CT for use with 5A CT	E243-16A	E244-16A
--	----------	----------

20 minute time lag

without limiting CT for use with 5A CT	E243-16J	E244-16J
--	----------	----------

* Scaled 0/100/120% of CT primary value.

Combined AC Ammeter and Maximum Demand Indicator

Where measurement of instantaneous and maximum demand currents are required, these instruments combine both movements in one case. The meter can also replace an existing AC ammeter. Meets the same specifications listed above.

Specifications

Accuracy:	Moving iron ammeter: Class 1.5 MDI: Class 3
Burden at 50Hz:	MI - 0.5VA, MDI - 2.5VA saturating CT - 2VA

Product Codes

Bezel size mm	72	96
Scale length mm*	65	94

Product codes

8 minute time lag

without limiting CT for use with 5A CT 3VA	-	E244-16Q
--	---	----------

15 minute time lag

without limiting CT for use with 5A CT 3VA	E243-16C	E244-16C
--	----------	----------

20 minute time lag

without limiting CT for use with 5A CT 3VA	-	E244-16H
--	---	----------

* Scaled 0/100/120% of CT primary value.

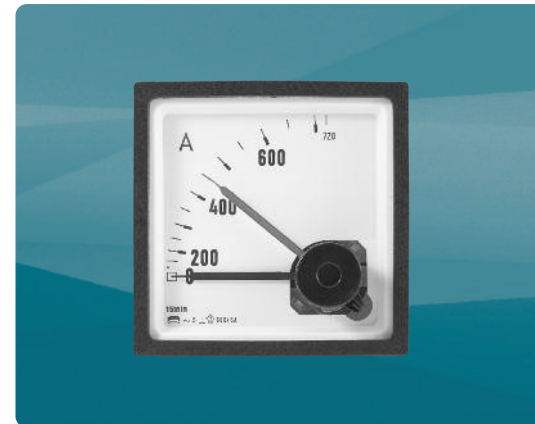

Connections

Maximum Demand Indicators

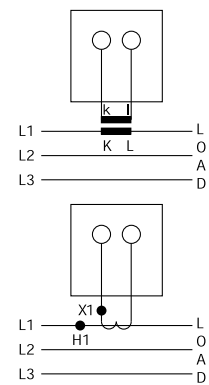

Moving Coil DC Ammeters and Voltmeters

Moving coil meters are suitable for all DC systems. The linear scale is calibrated down to zero and the accuracy maintained down to 10%. High currents are measured with separate shunts and suitably scaled indicators. Suppressed, centre and offset zero models are available.



Connections

DC Voltmeter

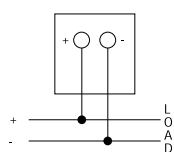

DC Ammeter

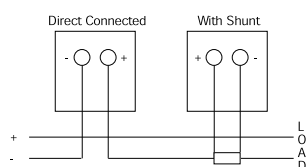

Specifications

Accuracy:	Class 1.5
Ratings:	Ammeters: 100 μ A-25A 4/20mA suppressed zero 40A for model E242, E243 and E244 up to 100A Volts: 50mV-600V 1/5V suppressed zero 50, 60, 75, 100, 150mV for use with shunts
Impedance:	Ammeters: 75mV internal shunt above 60mA Volts: 1000 Ω /V above 1V

Product Codes

Bezel size mm	48	72	96	144
Scale length mm	42	65	94	145

Product codes

Ammeters	E242-89A	E243-01A	E244-01A	E246-01A
Ammeters suppressed zero	E242-89R	E243-01R	E244-01R	E246-01R
Volts	E242-89V	E243-01V	E244-01V	E246-01V
Volts suppressed zero	E242-89S	E243-01S	E244-01S	E246-01S

Moving Coil Rectified AC Ammeters and Voltmeters

For high frequency or linear full scale AC measurements, these instruments measure average values of sinusoidal waveforms and are scaled in RMS values. The high quality silicon bridge rectifier gives a linear scale down to near zero, where some compression occurs.



Connections

AC Ammeter

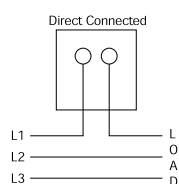

AC Voltmeter

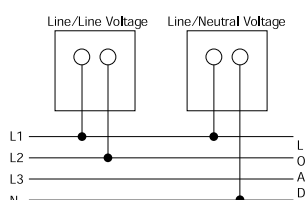

Specifications

Accuracy:	1.5% ES
Ratings:	Ammeters: 250 μ A-1A AC Over 1A via CTs
Volts:	15 - 600V AC direct connected. models available for use with VTs
Frequency:	50/60Hz, (Single frequencies 25Hz - 3kHz on request)

Product Codes

Bezel size mm	48	72	96	144
Scale length mm	42	65	94	145

Product codes

Ammeters	E242-89B	E243-01B	E244-01B	E246-01B
Volts	E242-89W	E243-01W	E244-01W	E246-01W

Process Indicators

Meters are used to check process functions locally or remotely at centralised controls. These moving coil instruments offer a wide variety of electrical and mechanical readouts and are operated by transducer, tachogenerator, thermocouple, resistance bulb or other DC analogue signals. Suppressed, centre and offset zero models are available on request.

Specifications

Accuracy:	Class 1.5
Ratings:	1, 2, 5, 10, 20mA 4/20mA suppressed zero

Product Codes

Bezel size mm	48	72	96	144
Scale length mm	42	65	94	145

Product codes

AC current	E242-89A	E243-01A	E244-01A	E246-01A
AC voltage	E242-89V	E243-01V	E244-01V	E246-01V
Phase angle	-	E243-014	E244-014	-
Watts	-	E243-015	E244-015	-
VAR	-	E243-016	E244-016	-
VA	-	E243-017	E244-017	-



Connections

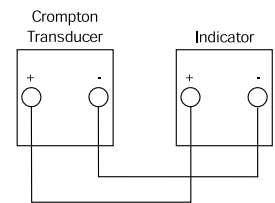

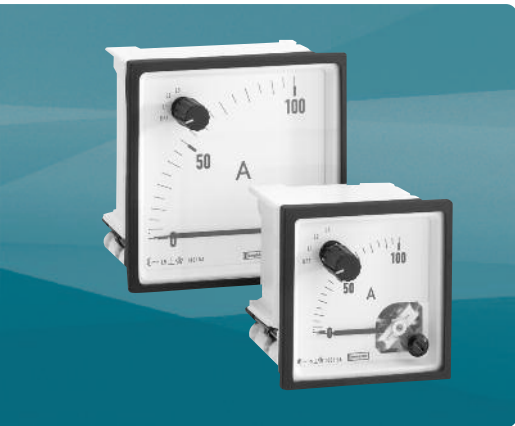

Moving Iron AC Ammeters and Voltmeters with Selector Switch

These 96mm and 72mm units offer Class 1.5 true RMS measurement of three-phase AC voltage or current with various switch notation options. The integral selector switch eliminates the necessity for a separate selector switch, saving valuable panel space and providing installation benefits. Both ammeters and voltmeters feature a slide-in dial, scaled for VT or CT values to suit application primary values.

These robust moving iron meters incorporate a clapper type repulsion design which utilises a pivot, hairspring and jewel movement. The bottom jewel is oil filled to provide damping while the top is sprung for resilience. Voltmeters are manufactured with internal voltage dropper resistors.

Features

- Integral selector switch
- True RMS measurement
- Slide-in dials
- Scaled for customer VT or CT primary values
- DIN 72 and DIN 96 models
- Terminal cover as standard
- Shock resistant sprung pivot and jewel movement
- x2 overload ammeters

Benefits

- Space and time saving
- Competitive cost
- Local indication
- Ease of installation
- Low maintenance
- Customised options and features

Applications

- Switchgear
- Distribution systems
- Generator sets
- Control panels
- Energy management
- Building management

Compliant with

- IEC61010-1B2001, EMC and LVD

Product Codes - AC Ammeters with Selector Switch

Code	Case size	Full scale deflection	Switch notation
E243-02E-G-LS**-C7-AMP3	72mm	0/5 A AC	OFF L1 L2 L3
E244-02E-G-LS**-C7-AMP3	96mm	0/5 A AC	OFF L1 L2 L3
E243-022E-G-LS**-C7-AMP3	72mm	0/5/10A AC	OFF L1 L2 L3
E244-022E-G-LS**-C7-AMP3	96mm	0/5/10A AC	OFF L1 L2 L3
E243-02E-G-LA**-C7-AMP3	72mm	0/1 A AC	OFF L1 L2 L3
E244-02E-G-LA**-C7-AMP3	96mm	0/1 A AC	OFF L1 L2 L3
E243-022E-G-LA**-C7-AMP3	72mm	0/1/2A AC	OFF L1 L2 L3
E244-022E-G-LA**-C7-AMP3	96mm	0/1/2A AC	OFF L1 L2 L3

**Insert applicable CT primary value.

Product Codes - AC Voltmeters with Selector Switch

Code	Case size	Full scale deflection	Switch notation	3-phase
E243-02Q-G-PM**-C7-SW6	72mm	0/120V AC	OFF L1L2 L2L3 L3L1	3W
E243-02Q-G-PZ**-C7-SW6	72mm	0/150V AC	OFF L1L2 L2L3 L3L1	3W
E243-02Q-G-PZ-PZ-C7-SW6	72mm	0/150V AC	OFF L1L2 L2L3 L3L1	3W
E243-02Q-G-RX-RX-C7-SW6	72mm	0/300V AC	OFF L1L2 L2L3 L3L1	3W
E243-02Q-G-SF-SF-C7-SW3	72mm	0/500V AC	L1L3 L1L2 L2L3 L3N L2N L1N	4W
E243-02Q-G-SJ-SJ-C7-SW3	72mm	0/600V AC	L1L3 L1L2 L2L3 L3N L2N L1N	4W
E244-02Q-G-PZ**-C7-SW6	96mm	0/150V AC	OFF L1L2 L2L3 L3L1	3W
E244-02Q-G-PZ-PZ-C7-SW6	96mm	0/150V AC	OFF L1L2 L2L3 L3L1	3W
E244-02Q-G-RX-RX-C7-SW6	96mm	0/300V AC	OFF L1L2 L2L3 L3L1	3W
E244-02Q-G-SF-SF-C7-SW3	96mm	0/500V AC	L1L3 L1L2 L2L3 L3N L2N L1N	4W
E244-02Q-G-SF-SF-C7-SW3	96mm	0/600V AC	L1L3 L1L2 L2L3 L3N L2N L1N	4W

**Insert applicable VT primary and secondary value, e.g. 15kV/110V.

Product Codes - Options

Description

Non reflecting glass window

Polycarbonate shatterproof window

Red supplementary pointer, externally adjustable

Red index mark (triangle)

Please state any required options at time of ordering.

General Specifications

Accuracy:	1.5% of full scale deflection (FSD)
Input rating:	Ammeter: 1A, 5A 1/2A or 5/10A moving iron, direct connected Voltmeter: 120, 300, 500 and 600V AC
Frequency:	50 or 60Hz (400Hz on request)
Burden at 50Hz:	Ammeters: 0.5VA Volts: 4-5VA max
Overload ammeter:	2 x In continuous for 2 minutes, 4 x In for 1 minute
Overload voltmeter:	1.2 x continuous 2 x for 5 seconds
Movement:	Moving iron shock resistant sprung pivot and jewel
Scale length:	DIN72: 54mm DIN96: 97mm
Enclosure style:	Panel mount to DIN42700
Enclosure material:	Grade UL94 VO
Bezel style:	Black matt DIN43802
Window:	Standard sheet glass
Terminals:	M4 captive screw clamp
Fixing:	2 corner fixing clamps with tensioning thumb screws
Mounting position:	Vertical mount to DIN16257, inclination of dial surface $\pm 15\%$
Damping time:	
Compliant with:	IEC61010-1B2001, CAT III 600V, EMC and LVD
Operating temperature:	-20°C to +55°C
Storage temperature:	-40°C to +75°C
Calibration temperature:	23°C
Relative humidity:	95% (non condensing)
Dimensions:	96DIN: 96mm high x 96mm wide x 63mm deep 72DIN: 72mm high x 72mm wide x 63mm deep
Panel cut out:	DIN96: 92mm x 92mm DIN72: 68mm x 68mm
IP protection:	IP40
Weight:	E243-02E 275g E243-02Q 300g E244-02E 360g E244-02Q 390g



Connections

AC Ammeters with Selector Switch

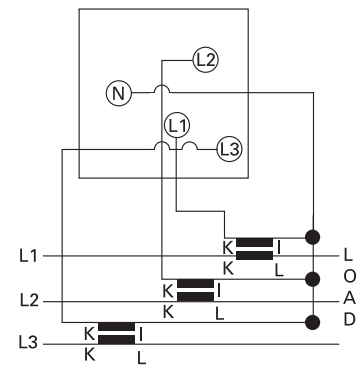

Dimensions

72DIN Models

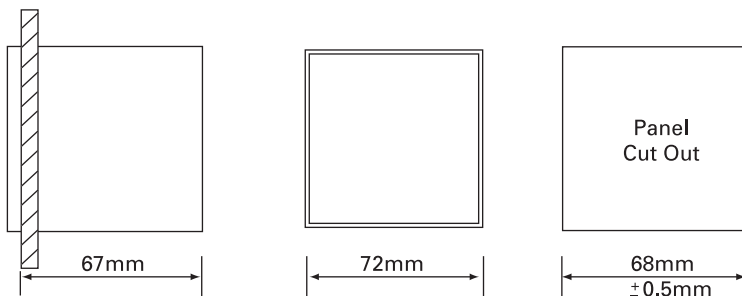

96DIN Models

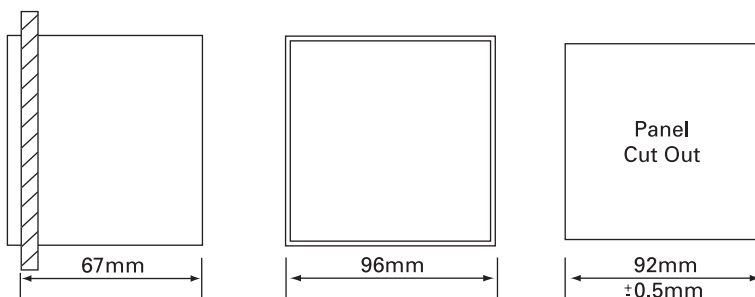

AC Voltmeters 3-phase 3-wire

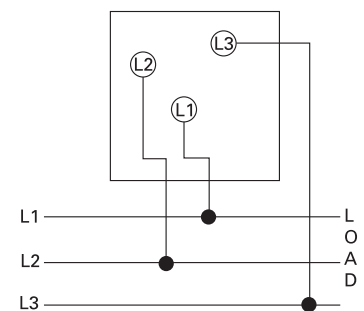

AC Voltmeters 3-phase 4-wire

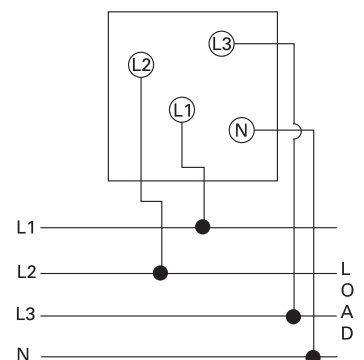

DIN Panel Meters – Long Scale

A range of 72mm and 96mm DIN style panel meters measuring all electrical parameters and featuring moving coil movements. All meters incorporate slide-in dials and terminal covers as standard. A range of customised options is available.

Movements

Moving Coil Meter

Centre cored, self shielding moving coil movement, using pivots, hairsprings and sprung jewels. Seven variations have been designed in movement ranges: all intermediate ranges are achieved by shunting the next lowest range. All DC voltmeters are 1000 ohms per volt, rectified product run at 900 ohms per volt. Millivolt meters use the 5 milliamp movement.

Frequency Meter

Meter uses a 100 microamps 4000 ohm movement driven by an EMC hard frequency conversion circuit.

Dials, Scales and Pointers

Standard dials are white matt with black printed scales and bar knife-edge pointers. Black dials with white or yellow scales and pointers are also available. Interchangeable slide-in dials are used on the E243 and E244 240° moving coil and frequency meter models.

Standard options include red supplementary pointers, and non-reflecting glass.

Features

- A range of the most popular long scale measuring instruments in 2 case sizes
- Shock resistant sprung pivot and jewel movement
- Terminal covers supplied as standard
- EMC hard frequency meter are fully EMC and LVD compliant

Benefits

- Local indication
- Ease of installation
- Minimal training
- Low maintenance
- Customised options and features

Applications

- Switchgear
- Distribution systems
- Generator sets
- Control panels
- Energy management
- Building management
- Utility power monitoring
- Process control
- Motor control



General Specifications

Performance:	BSEN60051
Measuring ranges:	DIN43701
Accuracy overload:	BSEN60051
Dimensions:	DIN43700
Scale marking generally to:	DIN43802
Magnetic influence:	BSEN60051
Safety:	BSEN61010-1
Terminals:	Clamp strap M4 for up to 25A. Clamp strap M8 for over 25A
Humidity range:	Up to 75% RH (non condensing)
Test voltage @50Hz:	3kV RMS for 1 minute
Overload AC current:	x 1.2 continuous, or x 10 for 5 seconds max
AC voltage and frequency:	x 1.2 continuous, or x 2 for 5 seconds max
Standard calibration:	23°C. Calibration at other temperatures available on request
Operating temperature:	-10°C to +55°C
Damping time:	Less than 3 seconds
Enclosure code:	IP52 as standard IP54 on request
Case and base:	Grade UL94V0 (Lexan 500R)
Case:	Dimensions and panel cut out conform to IEC473, DIN43700. Case made from glass filled polycarbonate self-extinguishing and non drip in accordance with UL94V-O
Bezel:	Slim-line DIN43802, black as standard
Bezel window:	Standard sheet glass, with zero adjusters where appropriate. Non reflecting glass windows are available
Installation;	Installations in switchboard panel or mosaic arrangement on equipment or machine with a panel thickness of up to 40mm in a horizontal or vertical plane
Fixing on panel:	Swivel captive fasteners, which can be fixed at either corner
Mounting position:	Normal vertical mounting or as indicated on the scale in accordance with DIN16257. A deviation of $\pm 15^\circ$ is permissible
Insulation group:	Insulation resistance more than $5M\Omega$ @ 500V
Environmental:	Measurement category III IEC 1010-1 Pollution degree 2 IEC 1010-1 Electrical rating 600V RMS (920V peak)
Approvals:	EMC and LVD

DIN16257 symbol meaning for calibration position

Vertical



Horizontal



Inclined

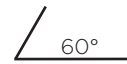

Inclination of dial surface.

Required orientation must always be stated when ordering if other than vertical mounting is required.

Dimensions

Moving coil measuring range

6-60A	C=67mm
>60A	C=78mm

Dimensions

D	A	B
72 x 72mm	68 x 68mm	4
96 x 96mm	92 x 92mm	4

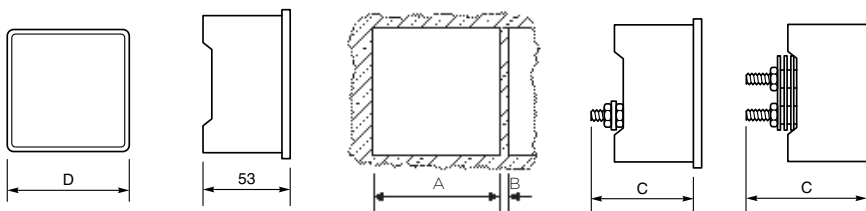



Long Scale Moving Coil AC Ammeters and Voltmeters

Moving coil rectified instruments measure average values of sinusoidal waveforms and are scaled in RMS values.

Specifications

AC Ammeter inputs	AC Voltmeter inputs
0/1A AC	0/60V AC
0/1.2A AC	0/100V AC
0/5A AC	0/120V AC
0/6A AC	0/125V AC
0/10A AC	0/140V AC
	0/150V AC
	0/250V AC
	0/300V AC
	0/400V AC
	0/500V AC
	0/600V AC

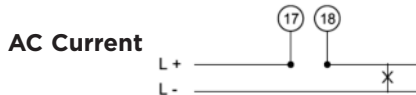
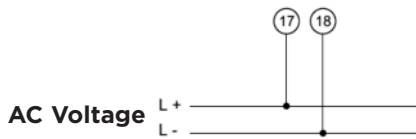

Accuracy:	Class 1.5
Frequency:	50/60Hz
Impedance:	Ammeters: 75mV internal shunt Voltmeters: 900 ohm/V

Dimensions

Bezel size mm	72	96
Scale length mm	65	94
Product codes		
AC Ammeters	E243-05B	E244-05B
AC Voltmeters	E243-05W	E244-05W



Long Scale Frequency Meters

Frequency meters use an integral electronic convertor and a moving coil indicator.

Specifications

Voltage inputs	Frequency inputs
100/125V AC	45/55Hz
200/250V AC	45/55Hz
380/400V AC	45/55Hz
100/125V AC	55/65Hz
200/250V AC	55/65Hz
380/400V AC	55/65Hz

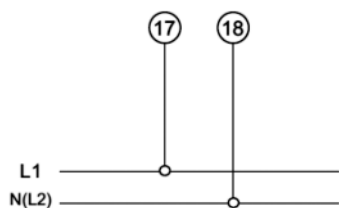

Accuracy:	Class 0.5
Burden:	<7VA

Dimensions

Bezel size mm	72	96
Scale length mm	65	94
Product codes		
Frequency meter	E243-41L	E244-41L

Long Scale Moving Coil DC Ammeters and Voltmeters

Moving coil meters are suitable for all DC systems. The linear scale is calibrated down to zero and the accuracy maintained down to 10%. Suppressed and centre zero models are available.

Specifications

DC Ammeter inputs	DC Voltmeter inputs
0/400uA DC	0/50mV DC
0/600uA DC	0/60mV DC
0/1mA DC	0/75mV DC
0/10mA DC	0/100mV DC
0/20mA DC	0/150mV DC
0/1A DC	0/2.5V DC
0/2.5A DC	0/10V DC
0/5A DC	0/30V DC
500/0/500uA DC	0/60V DC
1/0/1mA DC	0/100V DC
20/0/20mA DC	0/150V DC
4/20mA DC	0/250V DC
	0/300V DC
	0/400V DC
	0/500V DC
	0/600V DC
	50/0/50mV DC
	60/0/60mV DC
	75/0/75mV DC
	100/0/100mV DC
	150/0/150mV DC
	5/0/5V DC
	10/0/10V DC

Accuracy:	Class 1.5
Impedance:	Ammeters: 75mV internal shunt Voltmeters: 1000Ω/V

Dimensions

Bezel size mm	72	96
Scale length mm	65	94

Product codes

Ammeters	E243-05A	E244-05A
Ammeters centre zero	E243-05C	E244-05C
Ammeters suppressed zero	E243-05R	E244-05R
Voltmeters	E243-05V	E244-05V
Voltmeters centre zero	E243-05N	E244-05N



Elapsed Time Meters (Hours Run Meters)

Elapsed time meters (ETM) or hours-run meters monitor "ON/RUN" time of plant and equipment, allowing the user to effectively control production efficiency, cost estimation and service period monitoring for preventative maintenance. Time is measured in increments of 0.01h up to 99999.99 hours after which the meter automatically resets to zero. Meters are non-resettable before this time to prevent accidental resetting.

Specifications

AC	
Display:	99999.99
Voltage:	100-125V AC 200-250V AC 380-440V AC
Frequency:	50 or 60Hz
Operating temperature:	-25°C to +80°C
IP Protection:	IP52
Burden:	1VA (100-125V AC) 2VA (200-250V AC) 3.5VA (380-440V AC)
DC	
Display:	99999.99
Voltage:	12-36V DC 10-80V DC 110V DC
Operating temperature:	-20°C to +70°C
IP Protection:	IP52
Burden:	0.5VA (12-36V AC) 1VA (10-80V AC) 1.5VA (110V AC)

Elapsed Time/Hours Run Meters AC

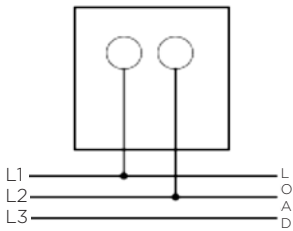

Elapsed Time/Hours Run Meters DC

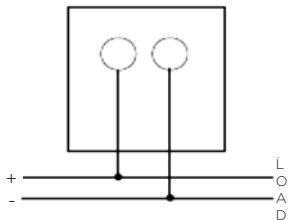

Bezel size product codes	48mm	72mm	96mm
100-125V AC 50Hz	M242-155-G-PL-ZH-C5	M243-155-G-PL-ZH-C5	M244-155-G-PL-ZH-C5
200-250V AC 50Hz	M242-155-G-RN-ZH-C5	M243-155-G-RN-ZH-C5	M244-155-G-RN-ZH-C5
380-440V AC 50Hz	M242-155-G-RY-ZH-C5	M243-155-G-RY-ZH-C5	M244-155-G-RY-ZH-C5
100-125V AC 60Hz	M242-156-G-PL-ZH-C6	M243-156-G-PL-ZH-C6	M244-156-G-PL-ZH-C6
200-250V AC 60Hz	M242-156-G-RN-ZH-C6	M243-156-G-RN-ZH-C6	M244-156-G-RN-ZH-C6
380-440V AC 60Hz	M242-156-G-RY-ZH-C6	M243-156-G-RY-ZH-C6	M244-156-G-RY-ZH-C6
12-36V DC	M242-157-G-BU-ZH-DC	M243-157-G-BU-ZH-DC	M244-157-G-BU-ZH-DC
10-80V DC	M242-157-G-NR-ZH-DC	M243-157-G-NR-ZH-DC	M244-157-G-NR-ZH-DC
110V DC	M242-157-G-PM-ZH-DC	M243-157-G-PM-ZH-DC	M244-157-G-PM-ZH-DC

Moving Coil Dual AC Ammeters & Voltmeters

Dual instruments can be used to measure a wide range of currents and voltages, and save both space and time by requiring only one panel cut out. The E244-80L allows for independent measurement of two AC voltages in one case. The E244-80F allows for independent measurement of two AC currents in one case.

Specifications

AC Ammeter inputs	AC Voltmeter inputs
0/1A AC	0/120V AC
0/1.2A AC	0/150V AC
0/5A AC	0/300V AC
0/6A AC	0/500V AC
0/10A AC	0/600V AC

Accuracy:	Class 1.5
Frequency:	50/60Hz
Impedance:	Ammeters: 75mV internal shunt Volts: 900 ohm/V

Dimensions

Bezel size mm	96
Scale length mm	94
Product codes	
AC Ammeters	E244-80F
AC Voltmeters	E244-80L

Dual Frequency Meters

Dual frequency instruments can be used to measure a wide range of frequencies, and save both space and time by requiring only one panel cut out. The E244-41D allows for independent measurement of two AC frequencies in one case.

Specifications

Voltage inputs	Frequency inputs
100/125V AC	45/55Hz
200/250V AC	45/55Hz
380/400V AC	45/55Hz
100/125V AC	55/65Hz
200/250V AC	55/65Hz
380/400V AC	55/65Hz

Accuracy:	Class 0.5
Burden:	<7VA

Dimensions

Bezel size mm	96
Scale length mm	94
Product codes	
Frequency meters	E244-41D



Connections

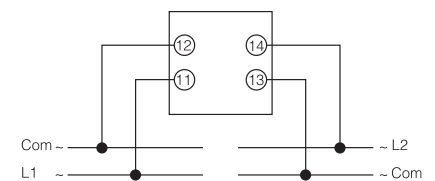

Connections

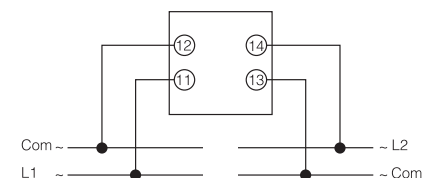

Phase Sequence Indicators

Electronic phase sequence indicators ensure correct phase rotation and the presence of all 3-phase supplies. Incorrect or loss of phase can cause serious damage in a wide range of electrical machines. Ship-to-shore supplies, mobile generators and remote installations are particularly vulnerable to this problem.



Voltage:	151/300V, 301/500V 100/150V (Model 244-12P only)
Frequency:	50/60Hz
Burden:	2.5VA/phase

Dimensions

Bezel size mm	72	96
Product codes		
Phase sequence indicator	243-12P	244-12P

Connections

Phase Sequence Indicators

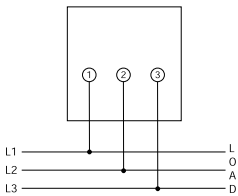

Phase Angle Meters

Electronic Phase Angle Meters

Phase angle meters indicate the phase displacement between current and voltage. They are used in applications where the phase angle must be monitored, for example with tariffs having VAR penalties, or to optimise generator power delivery.

Specifications

Accuracy:	Class 1.5
Ratings:	Current: 1A or 5A for CTs
	Voltage: 110V, 240V, 380V & 400V for VT use
Frequency:	50Hz, 60Hz
Burden at 50Hz:	Current: 1VA
	Voltage: 3VA per phase
Current range:	20-120%

Product Codes - Short-Scale Models Dimensions

Bezel size mm	72	96
Scale length mm	65	94
Product codes		
3-phase 3/4-wire balanced load	E243-42A	E244-42A



Connections

3-phase, 3-4-wire Balanced Systems

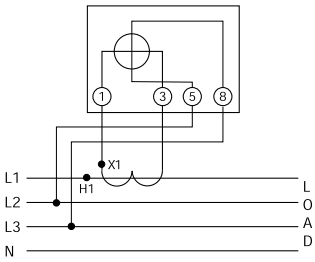
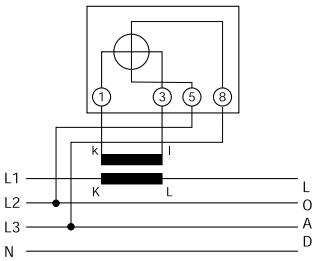



Power Factor

Power Factor indicators are suitable for generators or supplies operating in parallel. The scale calibrated $\cos 0.5 - 1 - 0.5$ indicates power low for inductive and capacitive loads.

Specifications

Voltage inputs

1-phase	3-phase 3-wire	3-phase 4-wire
63.5V AC	110V AC L/L	63.5V AC L/N
100V AC	120V AC L/L	69.3V AC L/N
110V AC	220V AC L/L	127V AC L/N
120V AC	230V AC L/L	132.7V AC L/N
220V AC	240V AC L/L	139V AC L/N
230V AC	380V AC L/L	220V AC L/N
240V AC	415V AC L/L	240V AC L/N
380V AC	440V AC L/L	254V AC L/N

Current inputs

1A AC	1A AC	1A AC
5A AC	5A AC	5A AC

Single-phase

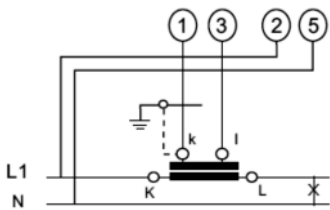

Three Phase Balanced Load

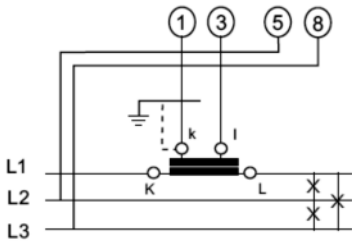

Accuracy:	Class 1.5
Measuring ranges:	Voltage: 85-115%
	Current: 20-120%
Overload:	120% of rated voltage & current continuous
Max Input:	600V
Frequency:	50/60Hz (45-65Hz max)
Burden:	Current: $\leq 0.2\text{VA}$ per phase
	Voltage: $\leq 1\text{VA}$ per phase

Dimensions

Bezel size mm	96
Scale length mm	94

Product codes

1-phase	E244-135
3-phase 3-wire balanced load	E244-136
3-phase 4-wire balanced load	E244-13D

LED Synchroscope

360° LED Synchroscope and Synchro Check Relay

Where manual parallelling of two AC systems is desired, the frequency of both systems can be monitored by an LED synchroscope. The systems are synchronised when the green LED is lit in the 12 o'clock position. The instrument is rated for continuous operation and connection. For the semi-automatic parallelling of two AC systems, the voltage, phase displacement and the frequency of both systems can be monitored by this LED synchroscope and synchro check relay. Controls for voltage, phase angle, and time delay are provided. The systems are synchronised when the green triangular LEDs are lit together with the GEN/BUS green LEDs. A dead bus option is also available.

Specifications

Ratings voltage:	63.5, 110, 120, 220, 230, 240, 380, 400, 415, 440, 480V 110/120V (115V nominal) 220/240V (230V nominal) 380/480V (430V nominal) Volts AC or via VT
Frequency:	40/65Hz
Burden at 50Hz:	4VA maximum Suitable for 1 or 3-phase systems
Safety:	IEC1010-1 (300V AC RMS installation degree 2)
Dielectric:	4kV rms for 1 minute
Isolation:	BUS/GEN/RELAY
Vibration:	To Lloyds shipping specification
*Phase difference:	+0-20°, +2%
*Voltage difference:	+0-20%, +/-2% 0-10% for models G and H
*Time delay:	0-2.5 seconds +10%
*Accuracy:	Synchronisation at T.DC is +1°

*Only for the 360° LED synchroscope and synchro check relay.

Dimensions

Bezel size mm	96	96	96
Scale length mm	360° LED	360° LED	360° LED
3- or 4-wire	Synchroscope	Synchroscope and synchro check	Synchroscope and synchro check relay (dead bus)
40-65Hz			

Product codes

110/120V	-	244-14GG-POBX	244-14HG-POBX
220/240V	-	244-14GG-R5BX	244-14HG-R5BX
380/480V	-	244-14GG-RUBX	244-14HG-RUBX
63.5V	244-14AG-NXYY	244-14LG-NXBX	244-14DG-NXBX
110V	244-14AG-PMYY	244-14LG-PMBX	244-14DG-PMBX
220V	244-14AG-R4YY	244-14LG-R4BX	244-14DG-R4BX
230V	244-14AG-RQYY	244-14LG-RQBX	244-14DG-RQBX
240V	244-14AG-RRYY	244-14LG-RRBX	244-14DG-RRBX
380V	244-14AG-RUYY	244-14LG-RUBX	244-14DG-RUBX
400V	244-14AG-SCYY	244-14LG-SCBX	244-14DG-SCBX
415V	244-14AG-SBYY	244-14LG-SBBX	244-14DG-SBBX
440V	244-14AG-SHYY	244-14LG-SHBX	244-14DG-SHBX
480V	244-14AG-SEYY	244-14LG-SEBX	244-14DG-SEBX

For the 244-14L and 244-14D models, the generator voltage is compared to the nominal input (bus) voltage specified at time of ordering. For the 244-14G and 244-14H models, the generator voltage is compared to the measured bus voltage.



Connections

360° LED Synchroscope

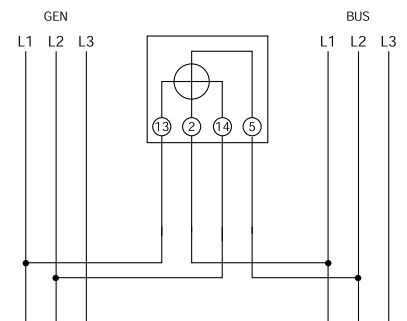

360° LED Synchroscope and Synchro Check Relay

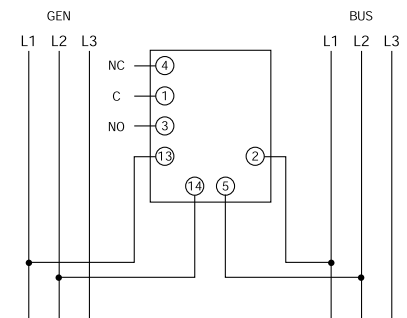

Power

Wattmeters & VAr meters

Self contained Wattmeters and VAr meters are able to measure active and reactive power in both balanced and un-balanced, single-, 3-phase 3-wire and 3-phase 4-wire systems. Wattmeters are ideal for clear precise analogue indication of power in applications such as power generation, industrial control and power distribution.

Specifications

Voltage inputs		
1-phase	3-phase 3-wire	3-phase 4-wire
63.5V AC	110V AC L/L	63.5V AC L/N
100V AC	120V AC L/L	69.3V AC L/N
110V AC	220V AC L/L	127V AC L/N
120V AC	230V AC L/L	132.7V AC L/N
220V AC	240V AC L/L	139V AC L/N
230V AC	380V AC L/L	220V AC L/N
240V AC	415V AC L/L	240V AC L/N
380V AC	440V AC L/L	254V AC L/N

Current inputs		
1A AC	1A AC	1A AC
5A AC	5A AC	5A AC

Accuracy:	Class 1.5
Measuring ranges:	Voltage: 85-115% Current: 20-120%
Overload:	120% of rated voltage & current continuous
Max Input:	600V
Frequency:	50/60Hz (45-65Hz max)
Power factor:	Unity power factor assumed range 0.5/1/0.5
Burden:	Current: $\leq 0.2VA$ per phase Voltage: $\leq 1VA$ per phase

Dimensions

Bezel size mm	96
Scale length mm	94

Wattmeter Product Codes

1-phase	E244-210
3-phase 3-wire balanced load	E244-211
3-phase 4-wire balanced load	E244-21C
3-phase 3-wire unbalanced load	E244-213
3-phase 4-wire unbalanced load	E244-214

VArmeter Product Codes

1-phase	E244-310
3-phase 3-wire balanced load	E244-311
3-phase 4-wire balanced load	E244-31C
3-phase 3-wire unbalanced load	E244-313
3-phase 4-wire unbalanced load	E244-314

Product Codes - Long Scale

Bezel size mm	96
Scale length mm	150

Wattmeter Product Codes

1-phase	E244-215
3-phase 3-wire balanced load	E244-216
3-phase 4-wire balanced load	E244-21D
3-phase 3-wire unbalanced load	E244-218
3-phase 4-wire unbalanced load	E244-219

VArmeter Product Codes

1-phase	E244-315
3-phase 3-wire balanced load	E244-316
3-phase 4-wire balanced load	E244-31D
3-phase 3-wire unbalanced load	E244-318
3-phase 4-wire unbalanced load	E244-319

Active Power

Single-phase
(one element)

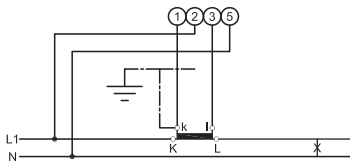

Three-phase, three-wire
AC supply with balanced load
(One element)

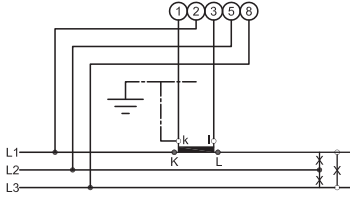

Three-phase, four-wire
AC supply with balanced load
(One element)

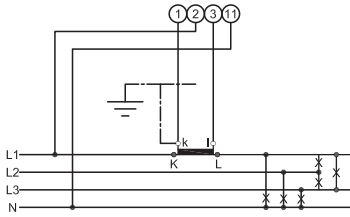

Three-phase, three-wire
AC supply with unbalanced load
(Two element)

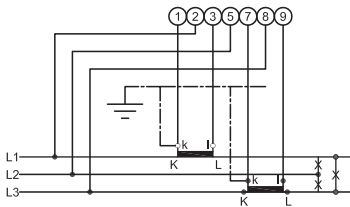

Three-phase, four-wire
AC supply with unbalanced load
(Three element)

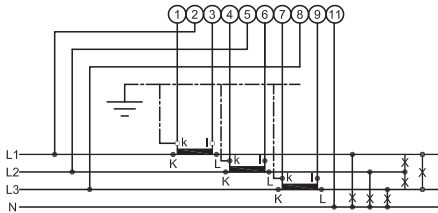

Reactive Power

Single-phase
(one element)

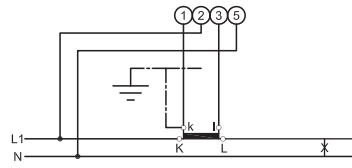

Three-phase, three-wire
AC supply with balanced load
(One element)

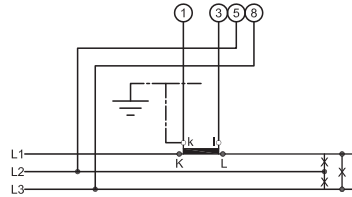

Three-phase, four-wire
AC supply with balanced load
(One element)

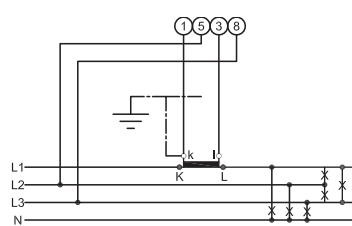

Three-phase, three-wire
AC supply with unbalanced load
(Two element)

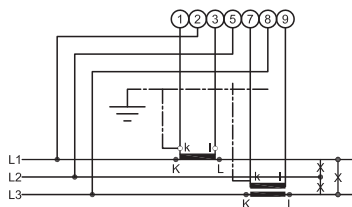

Three-phase, four-wire
AC supply with unbalanced load
(Three element)

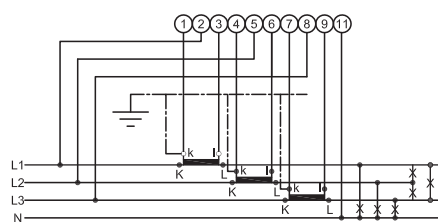

Instrument Selector Switches

Panel mounted selector switches offer a 7-position voltmeter switch and a 4-position ammeter switch for reading line-to-line or line-to-neutral voltage and phase current. Each switch can be supplied with either numbered or coloured annotation.

Specifications

Loading capacity:	SO1: 20A, 500V. SO3: 25A/480V
Switching capacity:	3kW at 220V, 5kW at 380V, 5.5kW at 500V
Isolating voltage:	SO1: 500V AC. SO3: 480V AC
Operating temperature:	-20°C to + 70°C
Mounting installation:	Two point front fixing
Dimensions:	48mm x 48mm
Panel cut out:	3 drilled holes
Compliant with:	LVD and EMC
IP protection:	SO1: IP65. SO3: IP54

Connections

Voltmeter Change-over Switches

For measuring 3-interconnected voltages and 3-phase voltage against N.

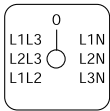

SO1

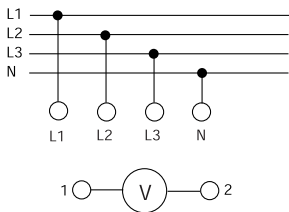

SO3

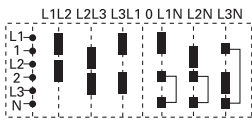

Ammeter-Change-over Switches

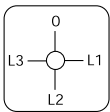

SO1

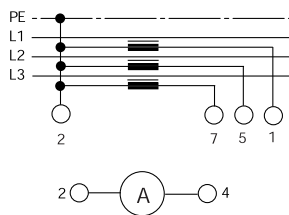

SO3

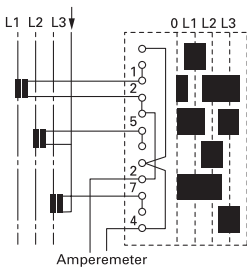

Product Codes

SO1 Three hole fixing 20A

SO1-SAB	4-position ammeter switch, L1-L2-L3-0
SO1-SAA	4-position ammeter switch, R-Y-B-0
SO1-SVE	7-position voltmeter switch, RY-YB-RB-0-RN-YN-BN
SO1-SVD	7-position voltmeter switch, L1L2-L2L3-L3L1-0-L1N-L2N-L3N

SO3 Three hole fixing 25A

SO3-SAB	4-position ammeter switch, L1-L2-L3-0
SO3-SVD	7-position voltmeter switch, L1L2-L2L3-L3L1-0-L1N-L2N-L3N

Dimensions

SO1 Three Hole Fixing 20 Amp

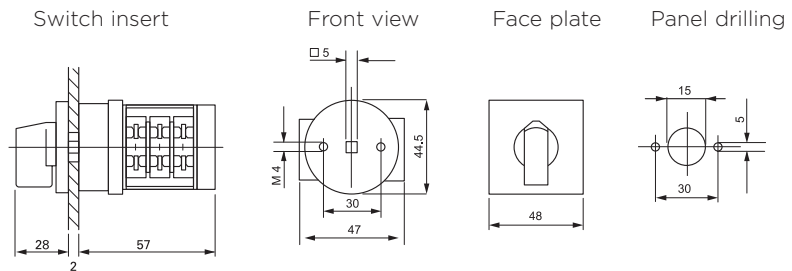

SO3 Three Hole Fixing 25 Amp

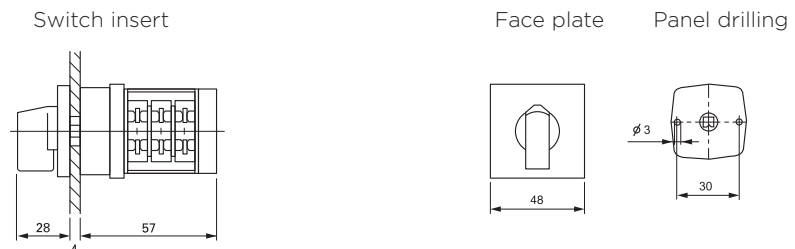

Saxon Indicators

A range of 2½", 3½" and 4½" surface mount panel meters utilising pivot and jewel mechanisms and offering IP54 protection. The range includes iron vane and moving coil AC and DC ammeters and voltmeters and frequency meters designed to perform in demanding environments.

Specifications - Frequency Meters

Accuracy:	0.15 = 60Hz, 1.25 = 400Hz, 0.15 = 50Hz, 0.25 = 55Hz
Voltage:	110/130V, 200/250V
Frequency:	50Hz or 60Hz
Burden:	4VA Maximum

Specifications - Moving Iron AC Ammeter and Voltmeter

Accuracy:	±2%
Rating:	Ammeters: 1 - 30A Voltmeters: 10V - 600V
Overload:	Ammeters: x1.2 for 2 hours, x10 for 5 seconds Voltmeters: x1.2 for 2 hours, x2 for 5 seconds
Burden:	Ammeters: 0.5VA Voltmeters: 4.5VA maximum

Specifications - Moving Coil DC Ammeter and Voltmeter

Accuracy:	±2%
Rating:	Ammeters: 1 - 30A Voltmeters: 10V - 600V
Operating temperature:	-20°C to 60°C (-4°F to 140°F)
Storage temperature:	-30°C to 70°C (-22°F to 158°F)

Dimensions

Specify number of fixing studs when ordering 2½" and 3½" meters. 4½" meters are supplied with 4 fixing studs.

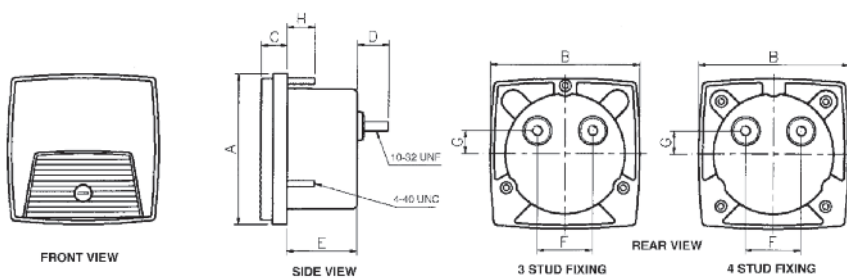

	A	B	C	D	E	F	G	H	J	K	L	M	N	P	Q
2½mm	68.6	68.6	11.8	14.6	32.0	25.4	10.4	12.7	55.9	31.0	46.5	26.9	23.9	47.8	23.9
inch	2.70	2.70	0.46	0.57	1.26	1.00	0.41	0.50	2.20	1.22	1.83	1.06	0.94	1.88	0.94
3½mm	88.9	88.9	11.8	14.6	36.0	25.4	10.4	12.7	69.9	40.2	60.3	34.8	28.5	57.0	28.5
inch	3.5	3.5	0.46	0.57	1.42	1.00	0.41	0.50	2.75	1.58	2.37	1.37	1.12	2.24	1.12
4½mm	112.0	123.2	12.7	16.3	30.5	28.4	0.38	12.7	70.9				51.6	90.4	50.8
inch	4.41	4.85	0.50	0.64	1.20	1.12	0.41	0.50	2.78				2.03	3.56	2.00

Panel cut-out

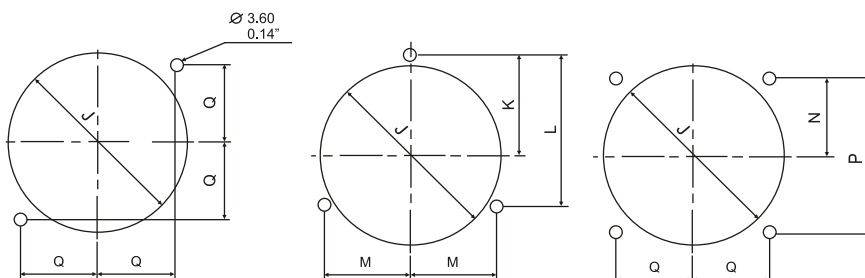

Features

- Three compact case sizes
- Withstands high levels of shock, vibration, dirt and humidity
- Pivot and jewel mechanisms

Benefits

- Complies with ANSI C39.1 (IEC 51)
- IP54 (NEMA 3) protection
- Instruments comply with BSEN61010-1 and meet IEC414 (BS5458)
- Pass dielectric test (2600V for 1min)

Applications

- Switchgear
- Distribution systems
- Generator sets
- Control panels
- Energy management
- Building management
- Utility power monitoring
- Process control
- Motor control

Compliant with

- UL approved file no. E203000

Connections

See page 25



AC Ammeter

Product Codes - AC Ammeter True RMS Reading (Accuracy ±2% ES)

Rating	Scaling	Cat. no.
5A	0-5A	(01*)-75AA-LSLS-C6-B*
10A	0-10A	(01*)-75AA-MTMT-C6-B*
15A	0-15A	(01*)-75AA-NDND-C6-B*
20A	0-20A	(01*)-75AA-NGNG-C6-B*
30A	0-30A	(01*)-75AA-NLNL-C6-B*
1A	Transformer rated	(01*)-75AA-LA**-C6-B*
5A	Transformer rated	(01*)-75AA-LS**-C6-B*

Product Codes - AC Voltmeter True RMS Reading (Accuracy ±2% ES)

150V	0-150V	(01*)-75VA-PZPZ-C6-B*
300V	0-300V	(01*)-75VA-RXRX-C6-B*
600V	0-600V	(01*)-75VA-SJSJ-C6-B*
150V	Transformer rated	(01*)-75VA-PZ**-C6-B*

Product Codes - DC Ammeters (Accuracy ±2% ES)

0-1mA	To suit requirements	(01*)-01AA-FA**-B*
0-5mA	0-5mA	(01*)-01AA-FXFX-B*
0-10mA	0-10mA	(01*)-01AA-GZGZ-B*
0-20mA	0-20mA	(01*)-01AA-HFHF-B*
0-50mA	0-50mA	(01*)-01AA-HYHY-B*
0-100mA	0-100mA	(01*)-01AA-JRJR-B*
0-200mA	0-200mA	(01*)-01AA-KAKA-B*
0-500mA	0-500mA	(01*)-01AA-KMKM-B*
0-1A0-1A	(01*)-01AA-LALA-B*	
0-2A0-2A	(01*)-01AA-LELE-B*	
0-5A0-5A	(01*)-01AA-LSLS-B*	
0-10A	0-10A	(01*)-01AA-MTMT-B*
0-50mV	To suit	(01*)-01AA-EC**-B*

Product Codes - Milliammeters Suppressed Zero (Accuracy ±2% ES)

4-20mA	To suit requirements	(01*)-01RA-HG**-B*
		**Specify scale value

Product Codes - DC Voltmeters Sensitivity 1000 Volt (Accuracy ±2% ES)

0-15V	0-15V	(01*)-01VA-NDND-B*
0-30V	0-30V	(01*)-01VA-NLNL-B*
0-50V	0-50V	(01*)-01VA-NTNT-B*
0-150V	0-150V	(01*)-01VA-PZPZ-B*
0-300V	0-300V	(01*)-01VA-RXRX-B*
0-600V	0-600V	(01*)-01VA-SJSJ-B*

Product Codes - Frequency Meters 120V, Self Contained

50Hz	45-55Hz	(01*)-41SA-PNAG-AG-B*
55Hz	45-65Hz	(01*)-41SA-PNAJ-AJ-B*
60Hz	55-65Hz	(01*)-41SA-PNAN-AN-B*

Product Codes - Elapsed Time Meters 9999.99 hours, non-resettable

110/130V, 50Hz	-	(01*)-155A-PNZH-C5-B*
200/250V, 50Hz	-	(01*)-155A-RNZH-C5-B*
480V, 50Hz	-	(01*)-155A-SEZH-C5-B*
110/130V, 60Hz	-	(01*)-156A-PNZH-C6-B*
200/250V, 60Hz	-	(01*)-156A-RNZH-C6-B*
480V, 60Hz	-	(01*)-156A-SEZH-C6-B*

To denote the required case size, replace the 01* in the catalogue number with 012, 013 or 014 for 2½", 3½" or 4½" respectively.

To denote the required stud fixing configuration, replace B* with B2 (2 stud), B3 (3 stud) or B4 (4 stud).



Frequency Meter

016 Series Fiesta Indicators

A robust range of short-scale 3½" surface mount panel meters offering IP55 protection and featuring a wide view contoured window. The Fiesta range includes iron vane and moving coil AC and DC ammeters and voltmeters, elapsed time and frequency meters and is ideally suited for demanding environments. Options include panel gasket.

Specifications - Elapsed Time Meter and Frequency Meter

Voltage:	100/125V, 200/250V or 480V AC
Frequency:	50Hz or 60Hz
Burden:	4VA maximum
Operating temperature:	-20°C to 65°C (-4°F to 149°F)
Storage temperature:	-30°C to 70°C (-22°F to 158°F)

Specifications - Iron Vane AC Ammeter and Voltmeter

Accuracy:	Ammeters 2.5%
Ratings:	Short-scale 1 - 80A
Voltmeters:	10V - 600V
Overload:	Ammeters: x1.2 for 2 hours, 10 x for 5 seconds
Voltmeters:	x1.2 for 2 hours, 2 x for 5 seconds
Burden:	Ammeters: 0.5VA; 1.5VA
Voltmeters:	4.5VA maximum
Operating temperature:	-20°C to 65°C (-4°F to 149°F)
Storage temperature:	-30°C to 70°C (-22°F to 158°F)

Specifications - Moving Coil DC Ammeter and Voltmeter

Accuracy:	1.5
Ratings:	Ammeters: 100µA to 30A
Voltmeters:	50mV - 600V
Overload:	Ammeters: x1.2 for 2 hours, 10 x for 5 seconds
Voltmeters:	x1.2 for 2 hours, 2 x for 5 seconds
Impedance:	Voltmeters: 1000 ohms per nominal volt
Operating temperature:	-20°C to 65°C (-4°F to 149°F)
Storage temperature:	-30°C to 70°C (-22°F to 158°F)

Dimensions

Instrument	Dim X inches	Dim X mm
MC. INSTS	1/4"-28 UNF	18.0
MI Voltmeter and AMM upto 59A	1/4"-28 UNF	18.0
MI Ammeter 60A and over	5/16"-24 UNF	23.0

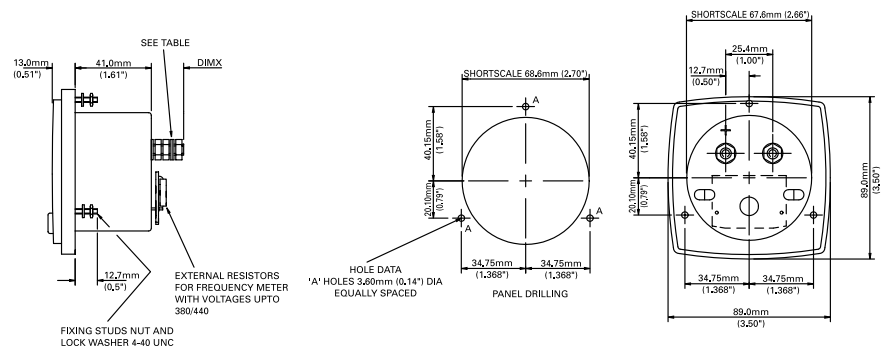

Connections

AMMETER DC
Direct connected (max rating 30A)

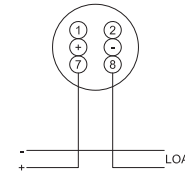

- 012-01A
- 013-01A
- 014-01A
- 016-01A

AMMETER AC

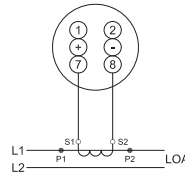

- 012-01B
- 013-01B
- 014-01B
- 016-01B
- 012-75A
- 013-75A
- 014-75A
- 016-02A

VOLTMETER DC
Direct connected (max rating 800V)

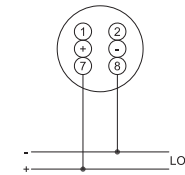

- 012-01V
- 013-01V
- 014-01V
- 016-01V

VOLTMETER AC/
FREQUENCY METER
V.T. operated

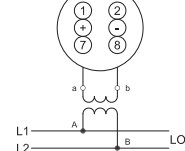

- 012-75V
- 013-75V
- 014-75V
- 016-02V
- 012-01W
- 013-01W
- 014-01W
- 016-01W



AC Ammeter Short-scale

AC Ammeter

Product Codes - True RMS Reading, Self Contained 50/60Hz

Rating	Scaling	Cat. no.
5A	0-5A	•016-02A*-LSLS-C7
10A	0-10A	•016-02A*-MTMT-C7
15A	0-15A	•016-02A*-NDND-C7
20A	0-20A	•016-02A*-NGNG-C7
30A	0-30A	•016-02A*-NLNL-C7
5A	Transformer rated	•016-02A*-LS**-C7

Product Codes - Moving Coil Rectified

100µA - 1A	To suit	•016-01B*-
------------	---------	------------

AC Overload Ammeter

Product Codes - True RMS Reading, Self Contained 50/60Hz

Rating	Scaling	Cat. no.
5A	0-5-30A	•016-026*-LSLS-C7
10A	0-10-60A	•016-026*-MTMT-C7
15A	0-15-90A	•016-026*-NDND-C7
20A	0-20-120A	•016-026*-NGNG-C7
30A	0-30-180A	•016-026*-NLNL-C7
5A	Transformer rated	•016-026*-LS**-C7



AC Overload Ammeter

AC Voltmeter

Product Code - True RMS Reading

Rating	Scaling	Cat. no.
150V	0-150V	•016-02V*-PZPZ-C7
300V	0-300V	•016-02V*-RXRX-C7
600V	0-600V	•016-02V*-SJSJ-C7
150V	Transformer rated	•016-02V*-PZ**-C7

Product Code - Moving Coil Rectified

15-600V	To suit	•016-01W*-
---------	---------	------------

DC Ammeters

Product Codes

Rating	Scaling	Cat. no.
0-50mV	To suit	•016-01A*-EC**
0-1mA	To suit	•016-01A*-FA**
0-5mA	To suit	•016-01A*-FX**
0-10mA	To suit	•016-01A*-HA**
0-20mA	To suit	•016-01A*-HF**

Suppressed Zero

Product Codes - Milliammeters - No Zero Set Unless Specified

Rating	Scaling	Cat. no.
4/20mA	To suit	•016-01RA*-HG**

Product Codes - Voltmeter - No Zero Set Unless Specified

1-5V	To suit	016-01S*-LM**
------	---------	---------------



AC Voltmeter

* Please state A or B at time of ordering. A = ANSI B = BS89

** Customer must state required scaling at time of ordering.

• UL approved

DC Voltmeters

Product Codes – Sensitivity 1000 /V

Rating	Scaling	Cat. no.
0-15V	0-15V	•016-01V*-NDND
0-30V	0-30V	•016-01V*-NLNL
0-50V	0-50V	•016-01V*-NTNT
0-150V	0-150V	•016-01V*-PZPZ
0-300V	0-300V	•016-01V*-RXRX
0-600V	0-600V	•016-01V*-SJSJ



DC Voltmeter

Frequency Meters

Product Codes – 120V, Self Contained

Rating	Scaling	Cat. no. standard case
50Hz centre frequency, -0.15 accuracy	45-55Hz	•016-41S*-PNAG-AG
55Hz centre frequency, -0.25 accuracy	45-65Hz	•016-41S*-PNAJ-AJ
60Hz centre frequency, -0.15 accuracy	55-65Hz	•016-41S*-PNAN-AN
400Hz centre frequency, -1.25 accuracy	360-440Hz	•016-41S*-PNBI-BI



Frequency Meter

Elapsed Time Meters

Product Codes – 99999.99 hours, Non-resettable

Rating	Scaling	Cat. no. standard case
110/130V, 50Hz	-	•016-155*-PNZH-C5
200/250V, 50Hz	-	•016-155*-RNZH-C5
480V, 50Hz	-	•016-155*-SEZH-C5
110/130V, 60Hz	-	•016-156*-PNZH-C6
200/250V, 60Hz	-	•016-156*-RNZH-C6
480V, 60Hz	-	•016-156*-SEZH-C6



Elapsed Time Meter

Transducer Indicators

Product Codes – DC Milliamp Rated

Rating	Scaling	Cat. no. standard case
Speed	To suit	016-012*
Frequency	To suit	016-013*
Phase angle	To suit	016-014*
Watts	To suit	016-015*
VArS	To suit	016-016*
VA	To suit	016-017*

* Please state A or B at time of ordering. A = ANSI B = BS89

** Customer must state required scaling at time of ordering.

• UL approved

Challenger Analogue Panel Meters

The Challenger range of analogue panel meters offers accurate measurement and indication of most electrical and electronic parameters in industry standard 1½", 2½", 3½" and 4½" case sizes. This innovative design features a detachable lower fascia plate, which allows the flexibility of either surface or window mounting. The fascia is simply unclipped to achieve the completely flush panel appearance of rear of panel window mounting.

The range offers AC and DC ammeters, voltmeters and frequency meters utilising a high torque pivot and jewel movement. AC moving coil rectified meters provide 1.5% accuracy of the full scale value and feature a rear zero adjuster screw for tamperproof installation. AC moving iron meters also provide 1.5% high accuracy and true RMS measurement.

Operation

The Challenger analogue panel meters utilise a traditional pivot and jewel movement, incorporating specially hardened steel pivots and a spring loaded jewel. This robust mechanism is ideally suited for all applications, including the most demanding conditions.

Moving Coil Meters

These meters offer a centre cored, self-shielding moving coil movement using pivots, hairsprings and sprung jewels. Variations in movement are limited by design. All DC voltmeters are 1000 ohms per Volt, moving coil rectified products run at 900 ohms per Volt. Millivolt meters use a 5 milliamps/50mV movement.

Moving Iron Meters

This clapper type repulsion design utilises a pivot, hairspring and jewel movement. The bottom jewel is oil filled to provide damping while the top is sprung for resilience. All voltmeters are manufactured with internal voltage dropper resistors.

Frequency Meters

Frequency meters utilise a 1mA/35 ohm DC moving coil movement driven by an EMC hard frequency conversion circuit.

Dials, Pointers and Scales

Standard dials are matt white with black printed scales and a tubular knife-edge black matt pointer. The 90° scales are balanced within 1% of scale length and feature a highly repeatable flattened arc scale shape, ensuring consistently accurate measurement readings. Dials are interchangeable between the Challenger meters for inputs within the published specifications of the meter. Options for non standard customised dials are available upon request.

Current Transformers and Shunts

Crompton Instruments, a Business Unit of TE Connectivity Ltd, offers a comprehensive range of current transformers and shunts, for driving the Challenger panel meters for the safe and simple measurement of AC and DC currents.

Our extensive range of current transformers provides accurate measurement of AC current and ratio matching to a consistent 5 or 1 amp secondary current, proportional to the primary current.

Our range of shunts ensures a DC millivolt signal exactly proportional to the system current for driving ammeters, providing accurate measurement of DC current up to 12000A, with secondary inputs of, 50, 60, 75 or 100mV DC to match the Challenger input.



Features

- Measurement and indication of AC amps, volts, frequency and DC signals
- Surface or window mounting
- Rear zero adjuster on moving coil meters
- High torque pivot and jewel movement
- True RMS measurement meters
- AC and DC inputs
- Up to 40A DC direct connected
- Up to 50A AC direct connected

Benefits

- AC moving iron and moving coil mechanisms
- Reduced inventory
- 4 ANSI standard case sizes
- Detachable lower fascia plate
- Easy to modify for distributors
- Through holes for back of panel mounting

Applications

- Marine panels
- Switchgear
- Distribution systems
- Control panels
- Embedded generation
- Energy management
- Building management
- Utility power monitoring
- Process control
- Motor monitoring

Compliant with

- ANSI C39.1 1981
- IEC 51
- UL3111-1
- EMC
- LVD
- UL and CUL file no: E236986

Specifications

Accuracy	
DC ammeters and voltmeters:	1.5% 0-100% of full scale deflection
AC ammeters and voltmeters:	Moving iron: 1.5% 10-100% of full scale deflection Moving coil: 1.5% 10-100% of full scale deflection
Frequency meters:	0.5% of end scale value
Input ratings	
DC moving coil ammeters:	50µA - 40A DC. (Model 361: 10A max)
DC moving coil voltmeters:	50mV - 600V DC
DC moving coil centre zero ammeters:	+/-50mA to +/-40A DC. (Model 361: 10A max)
DC moving coil centre zero voltmeter:	+/-50mV to +/-600V DC. Standard 1k ohm/volt
DC moving coil suppressed zero ammeters:	4/20mA DC
DC moving coil suppressed zero voltmeters:	1/5, 8/16, 16/32 or 12/24V DC
AC moving coil ammeters:	100µA - 750mA AC
AC moving coil voltmeters:	20 - 600V AC. Standard 900 ohms/volt
AC moving iron ammeters:	1 - 50A AC (Model 361: non applicable)
AC moving iron voltmeters:	3 - 600V AC (Model 361: non applicable)
Frequency:	100/130V, 200/250V, 360/440V, 50Hz, 60Hz or 400Hz (Model 361: non applicable)
Burden:	Ammeter 0.5VA Voltmeter: 4.5VA Frequency: 4VA
Overload:	1.2 continuous x 10 for 0.5 seconds
Enclosure	
Movement:	High torque pivot and jewel moving coil and moving iron
Scale balance:	Within 1% of scale length
Relative humidity:	25% - 80% nominal range of use
Operating temperature:	0°C to 40°C (-32°F to 104°F)
Storage temperature:	-20°C +55°C (-4°F to 131°F)
Case and lower mask:	Black matt case UL94V. Polycarbonate cover
Window:	Shatterproof polycarbonate
Surface mounting:	4 corner studs
Rear of panel mounting:	2 through hole mounts (Model 361: facility pending)
Compliant with	
UL and CUL:	61010B-1 File no: E236986
Performance:	ANSI C39.1 1981 and IEC 51
Scaling:	ANSI C39.1 1981
Safety:	IEC61010-1 (LVD) and BSEN61326:1998 (EMC)
Vibration:	ANSI C39.1 1981 cl. 5.13

Product Codes

Input	Model 361 cat. no.	Model 362 cat. no.	Model 363 cat. no.	Model 364 cat. no.
DC moving coil amps	361-01A	362-01A	363-01A	364-01A
DC moving coil volts	361-01V	362-01V	363-01V	364-01V
DC moving coil centre zero amps	361-01C	362-01C	363-01C	364-01C
DC moving coil centre zero volts	361-01N	362-01N	363-01N	364-01N
DC moving coil suppressed zero amps	361-01R	362-01R	363-01R	364-01R
DC moving coil suppressed zero volts	361-01S	362-01S	363-01S	364-01S
AC moving coil amps	361-01B	362-01B	363-01B	364-01B
AC moving coil volts	361-01W	362-01W	363-01W	364-01W
AC moving iron amps	N/A	362-02A	363-02A	364-02A
AC moving iron volts	N/A	362-02V	363-02V	364-02V
Frequency	N/A	362-41S	363-41S	364-41S

Please specify current, voltage, frequency and required options at time of ordering.

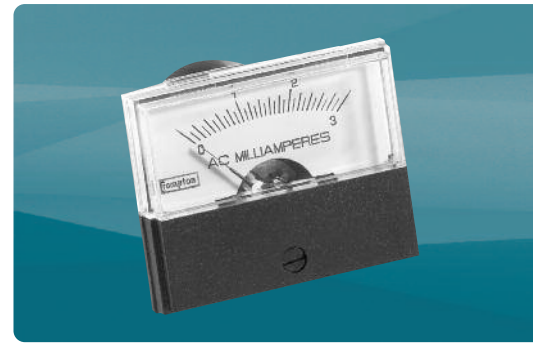

Model 361 (1 1/2")



Model 362 (2 1/2")



Model 363 (3 1/2")

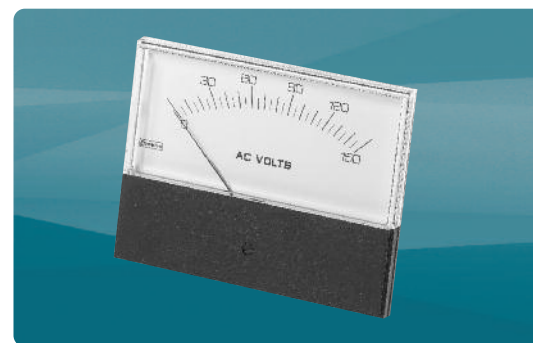

Model 364 (4 1/2")



Connections

DC Amps - Self contained

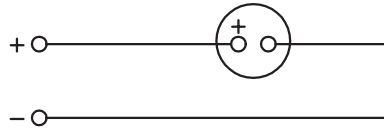

DC Amps - For use with external shunt

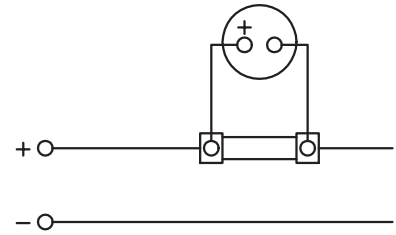

DC Volts

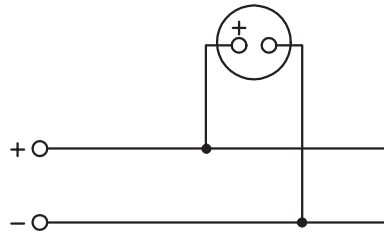

AC Amps - Self contained

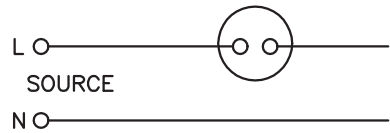

AC Amps - For use with current transformer

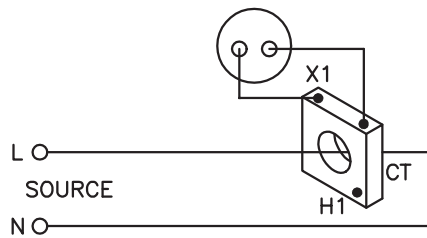

AC Volts

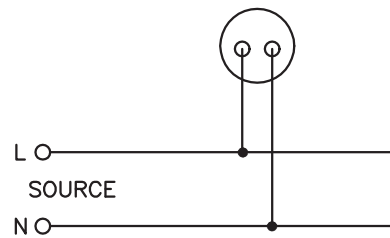

Frequency Meter

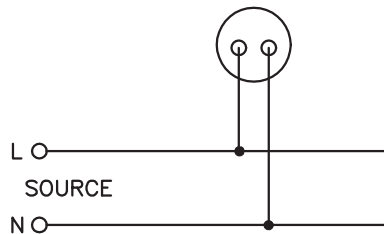

Dimensions - Surface Mount

Model 361

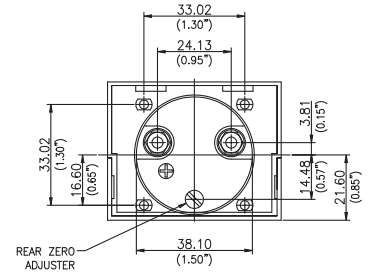
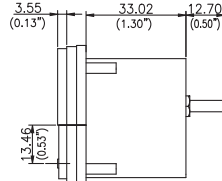
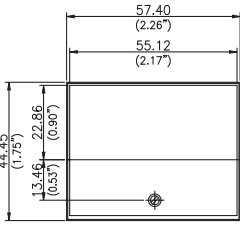

Model 362

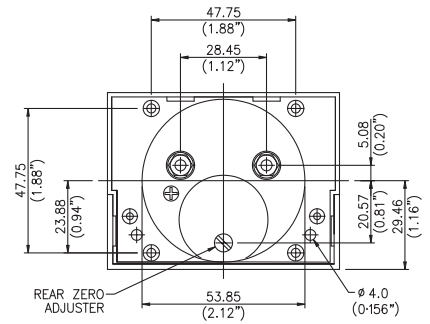
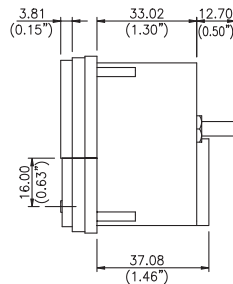
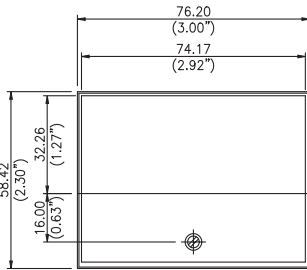

Model 363

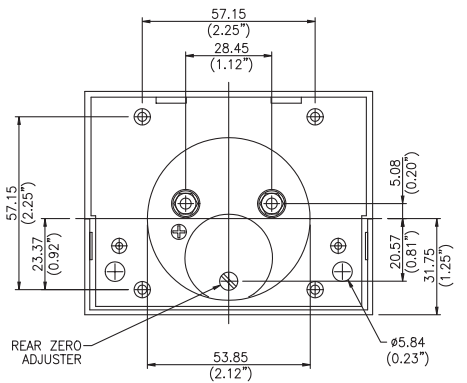
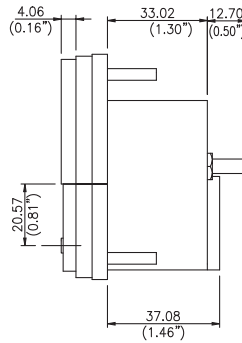
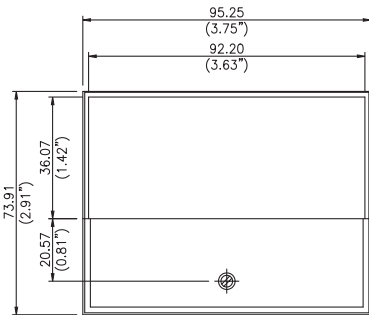

Model 364

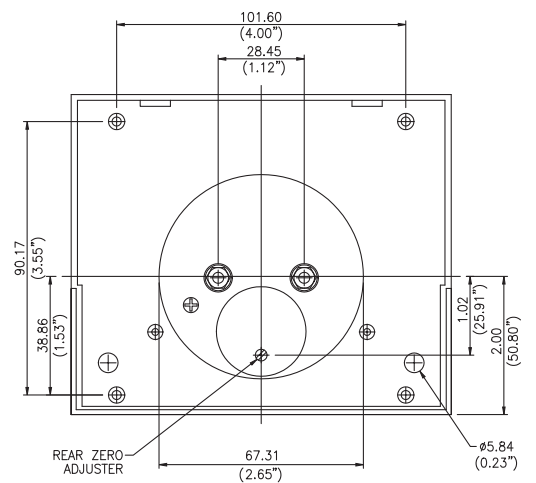
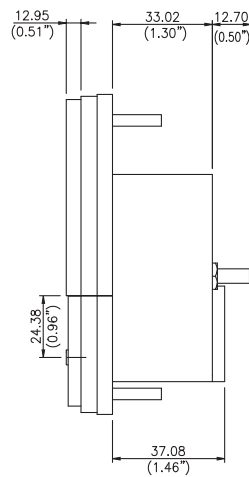
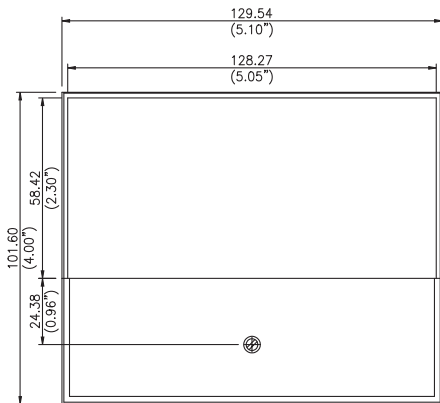

Dimensions - Panel Mount

Model 361
Surface Mount Cut-out

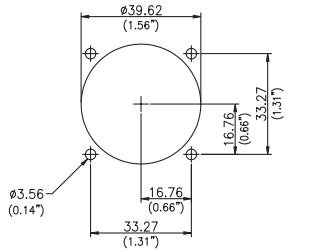

Window Mount Cut-out

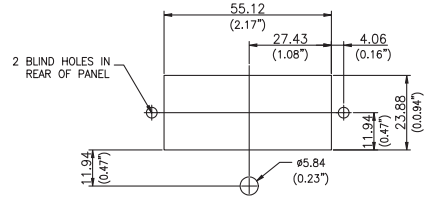

Model 362
Surface Mount Cut-out

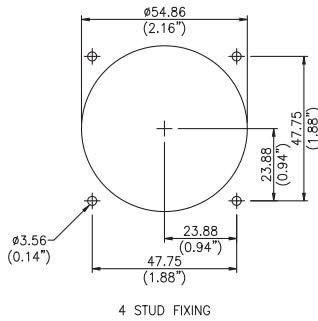

Window Mount Cut-out

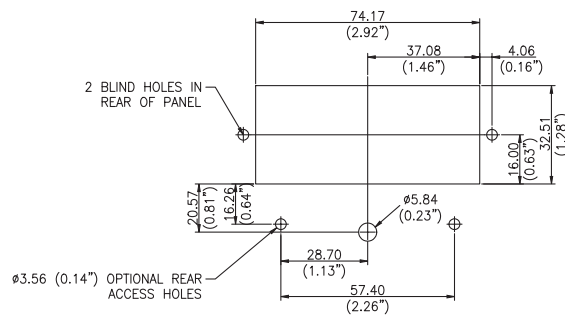

Model 363
Surface Mount Cut-out

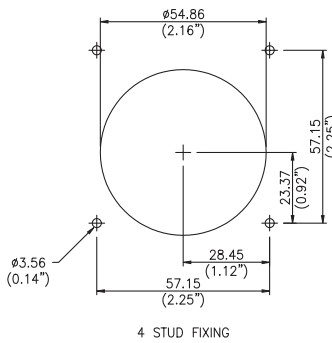

Window Mount Cut-out

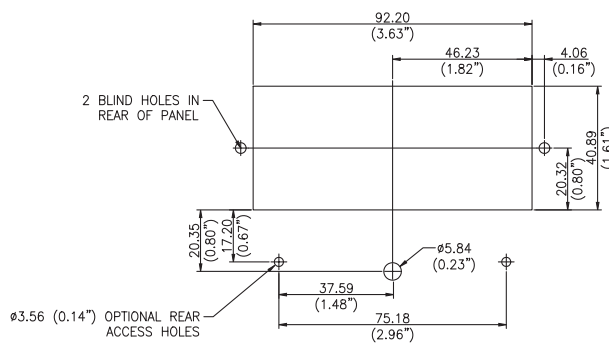

Model 364
Surface Mount Cut-out

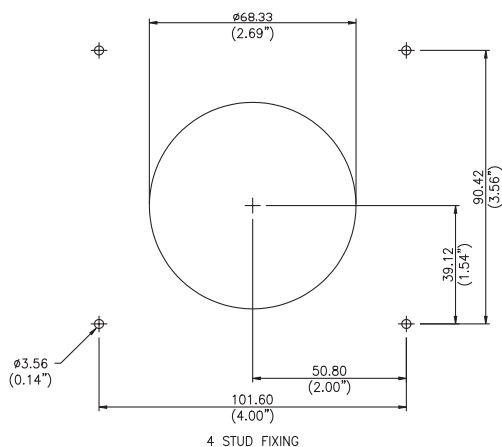

Window Mount Cut-out

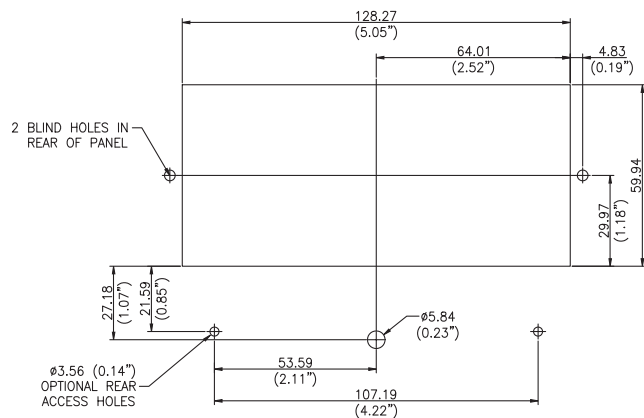

Sealed and Ruggedised Indicators

078/080/087 Series 240° Scale

The Crompton Instruments 078/080/087 series of heavy duty sealed instruments are designed to comply with the most stringent industrial, marine and military specifications.

This metal cased range offers bezel sizes of 57mm, 83mm and 110mm all fitted with toughened glass. Indicators comply with Ministry of Defence specification DEF STAN 66.7. and operate efficiently in the most adverse environments where extreme conditions of shock, vibration, dirt, humidity and temperature variation are present.

Description

Indicators have metal cases with bezel sizes of 50 x 57mm (083), 83mm Ø (084) and 110mm x 100mm (078/087). All indicators are fitted with toughened glass windows. The standard black matt finish can be replaced with options ranging from light admiralty grey to BS3181C No:697. To prevent fogging, all indicators have been dried, evacuated and filled with dry nitrogen during manufacturing. The case interior retains a constant pressure of at least 94kPa above the exterior with leakage not above the equivalent of 1.33 Pa ml/s of air. Except on model 083, panel sealing gaskets are standard equipment.

Standard instrument dials are finished in acrylic white matt with black printing and a parallel pointer. Scales form a true arc with zero on the left hand-side. Options include dial illumination, a centre, off-set or suppressed zero, colour index lines, bands, zones or segments, a black dial with white printing, and customer logo.

Specifications

Performance:	BSEN60051 (IEC51) DEF STAN 66-7 on request (087 only)
Accuracy:	Refer to Product Range table
Scaling:	BS89, BS3693 or DEF STAN 66-7 and 66-9
Dielectric test:	2kV r.m.s to BSEN61010-1
Overloads:	x 1.2 rated current for 2 hours x 10 rated current for 5 seconds x 1.2 rated voltage for 2 hours x 2 rated voltage for 5 seconds
Enclosure code:	IP67 (NEMA 6 and 6P)
Case:	Black matt metal filled with dry nitrogen
Bezel:	Black matt metal. Optional admiralty grey No. 697
Bezel window:	Toughened glass
Operating temperature:	-40°C to +70°C (-40°F to +158°F)
Storage temperature:	-55°C to +85°C (-67°F to 185°F)
Standard calibration:	23°C (73°F)
Approvals:	EMC and LVD DEF 66.7

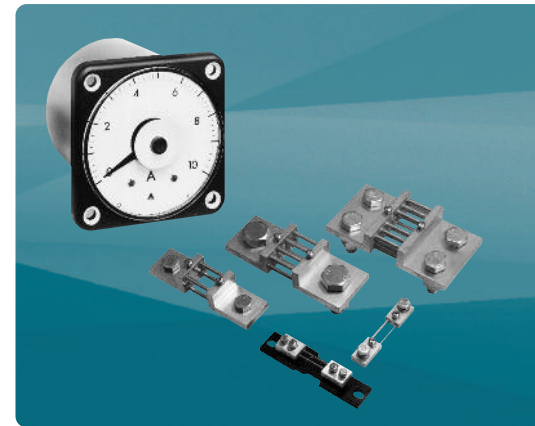

Features

- Designed specifically for stringent industrial, marine and military specifications
- An extensive range of high accuracy measuring instruments in 3 case sizes
- Rugged Hi-Q taut-band suspension
- Bump, shock and vibration proof

Benefits

- Complies with BSEN60051 (IEC51)
- IP67 (NEMA 6 and 6P) protection
- Dial illumination option
- Parallax error-free platform dials for 078/087. Optional for 083/084

Applications

- Switchgear
- Distribution systems
- Generator sets
- Control panels
- Utility power monitoring
- Process control
- Motor control
- Marine
- Military

Approvals

- DEF STAN 66.7

Product Range – 078/080/087 Series 240° Scale

Type of instrument	Ranges	Accuracy class	Burden VA	Case code depth behind the bezel				Product code
DC ammeter shunt operated	50, 60, 75, 100, 150mV	2.5	See T118***	57	-	-	-	083-05A
DC ammeter shunt operated	50, 60, 75, 100, 150mV	1.5	See T118***	-	59	-	-	084-05A
DC ammeter shunt operated	50, 60, 75, 100, 150mV	1.5	See T118***	-	-	86	-	078-05A
DC ammeter shunt operated	50, 60, 75, 100, 150mV	1.5	See T118***	-	-	-	86	087-11A
DC ammeter	200µA-30A	2.5	See T118***	57	-	-	-	083-05A
DC ammeter	200µA-30A	1.5	See T118***	-	59	-	-	084-05A
DC ammeter	200µA-30A	1.0	See T118***	-	-	86	-	078-05A
DC ammeter	200µA-30A	1.0	See T118***	-	-	-	86	087-11A
DC ammeter suppressed zero	4/20mA	2.5	See T118***	57	-	-	-	083-05R
DC ammeter suppressed zero	4/20mA	1.5	See T118***	-	59	-	-	084-05R
DC ammeter suppressed zero	4/20mA	1.5	See T118***	-	-	86	-	078-05R
DC ammeter suppressed zero	4/20mA	1.5	See T118***	-	-	-	86	087-11R
DC voltmeter	50mV-600V	2.5	See T118***	57	-	-	-	083-05V
DC voltmeter	50mV-600V	1.5	See T118***	-	59	-	-	084-05V
DC voltmeter	50mV-800V	1.5	See T118***	-	-	86	-	078-05V
DC voltmeter	50mV-800V	1.0	See T118***	-	-	-	86	087-11V
DC voltmeter suppressed zero	1/5V	1.5	See T118***	-	-	86	-	078-05S
DC voltmeter suppressed zero	1/5V	1.5	See T118***	-	-	-	86	087-11S
AC rectified ammeter	200µA-1A	2.5	See T118***	57	-	-	-	083-05B
AC rectified ammeter	200µA-1A	2.5	See T118***	-	59	-	-	084-05B
AC rectified ammeter	200µA-30A	1.5	See T118***	-	-	86	-	078-05B
AC rectified ammeter	200µA-30A	1.5	See T118***	-	-	-	86	087-11B
AC rectified voltmeter	15-600V 25Hz/3kHz	2.5	See T118***	57	-	-	-	083-05W
AC rectified voltmeter	15-600V 25Hz/3kHz	2.5	See T118***	-	59	-	-	084-05W
AC rectified voltmeter	15-600V 25Hz/3kHz	1.5	See T118***	-	-	86	-	078-05W
AC rectified voltmeter	15-600V 25Hz/3kHz	1.5	See T118***	-	-	-	86	087-11W
Elapsed time meter	50 or 60Hz, 100-400V*			57	-	-	-	083-155 or 156
Elapsed time meter	12, 24V DC			57	-	-	-	083-151
Elapsed time meter	50 or 60Hz, 100-400V*			-	59	-	-	084-155 or 156
Elapsed time meter	12, 24V DC			-	59	-	-	084-151
Elapsed time meter	50 or 60Hz, 100-400V*			-	-	86	-	078-155 or 156
Frequency meter	50/60/400Hz 100-440V*	0.5%	4	57	-	-	-	083-41S
Frequency meter	50/60/400Hz 100-440V*	0.5%	4	-	59	-	-	084-41S/089-41S
Frequency meter	50/60/400Hz 100-440V*	0.5%	4	-	-	86	86	078/087-41L
Temperature indicator	RTD	1.5	See T118***	-	-	86	-	078-45 R
Wattmeter or VArmeter	0.2-10A/100-440V*	Balanced	Current	-	-	132	132	078/087-21 or 31
Transducer operated indicator	1, 5, 10, 20 or 4/20mA	1.0	See T118***	57	-	-	-	083-05
Transducer operated indicator	1, 5, 10, 20 or 4/20mA	1.0	See T118***	-	59	-	-	084-05
Transducer operated indicator	1, 5, 10, 20 or 4/20mA	1.0	See T118***	-	-	86	-	078-05
Transducer operated indicator	1, 5, 10, 20 or 4/20mA	1.0	See T118***	-	-	-	86	087-11

* 100-440V = (100/125, 200/250, 380/440).

*** The T118 technical sheet is available on request.

080 Series 90° Scale

A range of metal case, sealed instruments for industrial and military applications involving extreme shock, vibration, temperature, dirt and humidity. Bezel sizes 57mm, 83mm comply with Ministry of Defence specification DEF STAN 66-7 or DEF STAN 66-9 for all standard ratings.

Description

Two bezel sizes of 57 x 57mm (083) and 83mm Ø (084), with barrel diameters of 53mm (083) and 67mm (084) and toughened glass windows are used throughout the series. To avoid fogging they are dried, evacuated and filled with dry nitrogen. Panel sealing gaskets are provided as standard with the exception of Model 083. Models 083 and 084 have steel cases with fixing holes in the flange. Sealed zero adjusters are provided. Standard instrument dials are finished in a white matt with black printing and parallel pointer. The scales form a true arc with zero on the left.

Options

Available options include dial illumination, a centre, off-set or suppressed zero, colour index lines, bands, zones or segments, a black dial with white printing and customer logo. Instruments operated by separate transducers indicate watts, VAR, frequency, phase angle, current, voltage and other physical/mechanical parameters are also available. Illumination options as follows:

Models 083/084: Edge, white or red bulb, 12 or 24V, illumination.



Specifications

Performance:	BSEN60051 (IEC51) DEF STAN 66-7 and 66.9 on request (084 only)
Accuracy:	Class 2.5 Frequency meter 0.5% of mid frequency
Scaling:	To BS89, BS3693 or DEF STAN 66-7 and 66-9
Dielectric test @ 50 Hz:	2kV RMS; <50V 500V RMS All for 1 minute
Overloads:	x 1.2 rated current or voltage for 2 hours x 10 rated current for 5 seconds x 2 rated voltage for 5 seconds
Burden:	AC ammeter: 1VA maximum AC voltmeter: 3VA maximum
Frequency meter:	4VA maximum
Elapsed time meter:	2.5VA maximum
Enclosure code:	IP67 (NEMA 6 and 6P)
Case:	Black matt metal filled with dry nitrogen
Bezel:	Black matt metal
Bezel window:	Toughened glass
Operating temperature:	-40°C to +70°C (-45F to +158°F)
Standard calibration:	23°C (73°F)
Approvals:	EMC and LVD DEF 66.7 and 66.9

Product Range – 080 Series 90° Scale

Type of instrument	Ranges	Case code		Product code
		083	084	
AC ammeter moving iron	1-30A	✓	-	083-75A
AC ammeter moving iron	1-30A	-	✓	084-75A
AC voltmeter moving iron	5-300V	✓	-	083-75V
AC voltmeter moving iron	5-300V	-	✓	084-75V
DC ammeter shunt operated	50, 60, 75, 100, 150mV	✓	-	083-80A
DC ammeter shunt operated	50, 60, 75, 100, 150mV	-	✓	084-80A
DC ammeter	50µA-30A	✓	-	083-80A
DC ammeter	50µA-30A	-	✓	084-80A
DC ammeter suppressed zero	4/20mA	✓	-	083-80R
DC ammeter suppressed zero	4/20mA	-	✓	084-80R
DC voltmeter	50mV-300V, 1000ff/V	✓	-	083-80V
DC voltmeter	50mV-300V	-	✓	084-80V
DC voltmeter suppressed zero	1/5V	-	✓	084-80S
AC rectified ammeter	100µA-500mA.25Hz/3kHz	✓	-	083-80B
AC rectified ammeter	100µA-500mA.25Hz/3kHz	-	✓	084-80B
AC rectified voltmeter	15-600V, 900ff/V	✓	-	083-80W
AC rectified voltmeter	15-600V	-	✓	084-80W
Elapsed time meter (99999.9)	12 or 24V DC	✓	✓	082/083/084-151
Elapsed time meter (99999.9)	50Hz/100-440V*	✓	✓	083/084-155
Elapsed time meter (99999.9)	60Hz/100-440V*	✓	✓	083/084-156
Frequency meter	50 or 60 or 400Hz/100-440V*	✓	-	083-41S
Frequency meter	50 or 60 or 400Hz/100-440V*	-	✓	084-41S
Transducer indicator speed	1, 5, 10, 20, and 4/20mA	-	✓	084/802
Transducer indicator frequency	1, 5, 10, 20, and 4/20mA	-	✓	084/803
Transducer indicator phase angle	1, 5, 10, 20, and 4/20mA	-	✓	084/804
Transducer indicator watts	1, 5, 10, 20, and 4/20mA	-	✓	084/805
Transducer indicator VArS	1, 5, 10, 20, and 4/20mA	-	✓	084/806
Transducer indicator VA	1, 5, 10, 20, and 4/20mA	-	✓	084/807

*100-440V – (100/125 or 200/250 or 380/440).

Dimensions

Model 083

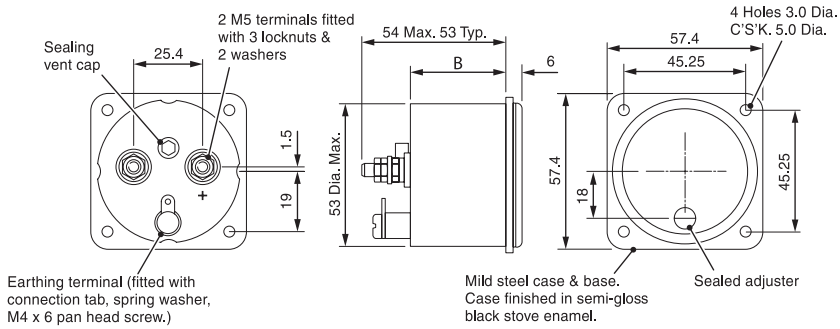

B

083-80 33.6

083-75 37.6

Model 084

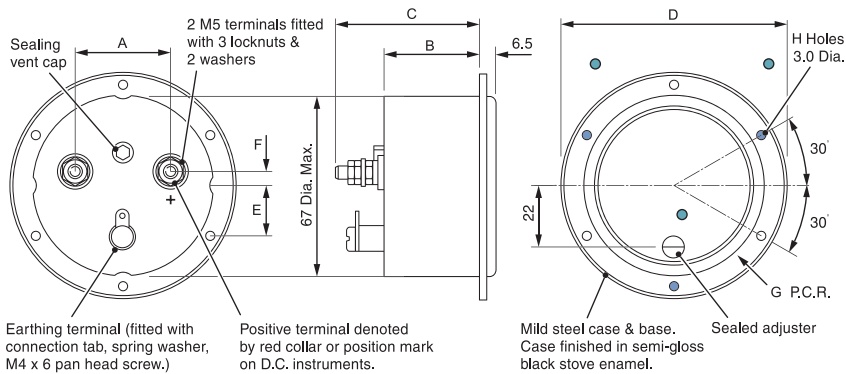

*When fitted with terminal shunt for ranges above 20 amps.

	A	B	C	D	E	F	G	H
084-80	35	33.5	59	82.5	20	5	36.5	6 off
084-75	35	38	64	82.5	20	5	36.5	6 off

Panel Cut out 68.3 ϕ - Holes 3.8 ϕ

These  holes on 084 only.



About TE Connectivity

TE Connectivity is a global, \$12.1 billion company that designs and manufactures over 500,000 products that connect and protect the flow of power and data inside the products that touch every aspect of our lives. Our nearly 100,000 employees partner with customers in virtually every industry – from consumer electronics, energy and healthcare, to automotive, aerospace and communication networks – enabling smarter, faster, better technologies to connect products to possibilities.

While TE Connectivity (TE) has made every reasonable effort to ensure the accuracy of the information in this catalogue, TE does not guarantee that it is error-free, nor does TE make any other representation, warranty or guarantee that the information is accurate, correct, reliable or current. TE reserves the right to make any adjustments to the information contained herein at any time without notice. TE expressly disclaims all implied warranties regarding the information contained herein, including, but not limited to, any implied warranties of merchantability or fitness for a particular purpose. The dimensions in this catalogue are for reference purposes only and are subject to change without notice. Specifications are subject to change without notice. Consult TE for the latest dimensions and design specifications. TE Connectivity and TE connectivity (logo) are trademarks. CROMPTON is a trademark of Crompton Parkinson Limited and is used under licence. Other trademarks are property of their respective owners.

TE Energy – innovative and economical solutions for the electrical power industry: cable accessories, connectors & fittings, insulators & insulation, surge arresters, switching equipment, street lighting, power measurement and control.

Tyco Electronics UK Ltd
TE Energy
Freebournes Road
Witham, Essex CM8 3AH

Registered office:
Faraday Road, Dorcan
Swindon, SN3 5HH
Reg. no. 550 926

Phone: +44 (0)870 870 7500
Fax: +44 (0)870 240 5287
Email: crompton.info@te.com

www.crompton-instruments.com
<http://energy.te.com>

